

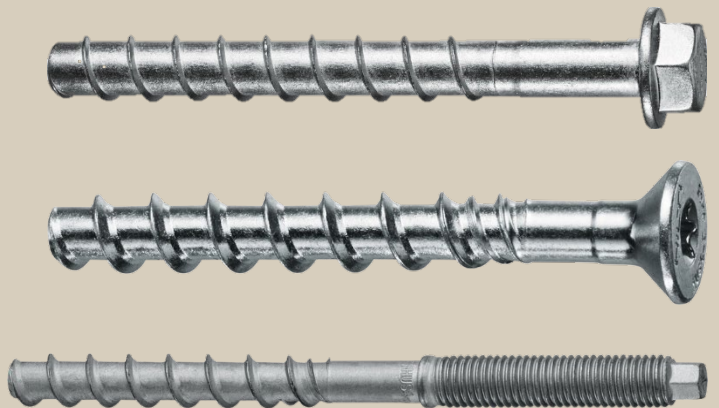

HUS4 Screw anchor

Product Technical Datasheet

Update: Sep 24



Steel-to-concrete-HUS4	Page no:02
Steel-to-concrete-HUS4-HR/CR	Page no:13
Steel-to-masonry-HUS4	Page no:23
Steel-to-masonry-HUS4-HR/CR	Page no:29
Temporary fastening	Page no:35
Hollow core slabs	Page no:41
Metal decks	Page no:50



HUS4 Screw anchor

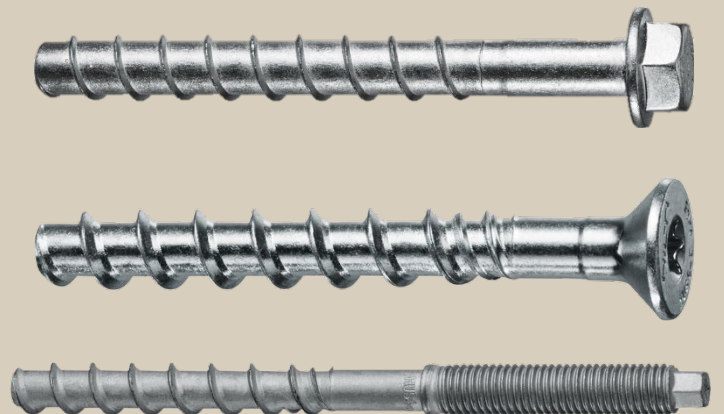

Product Technical Datasheet
Steel-to-concrete
Update: Sep 24







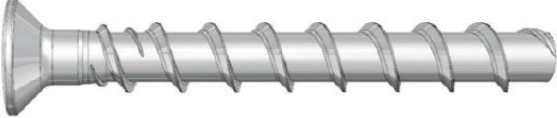

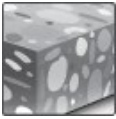

HUS4 Screw anchor for use in concrete

High performance screw anchor for single point fastening

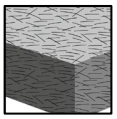
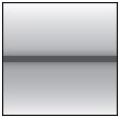
Anchor version		Benefits
	HUS4-H(F) (8-16)	- High productivity - less drilling and fewer operations than with conventional anchors
	HUS4-C (8-10)	- ETA cracked and uncracked concrete - ETA approval for Seismic C1 and C2 - ETA approval for adjustability (unscrew-rescrew)
	HUS4-A(F) (10-14)	- Smaller edge and spacing distance - Three embedment depths for maximum design flexibility and flexible design for concrete cone capacity - No cleaning required for size 8 to 14 - HUS4-HF and HUS4-AF with multilayer coatings for additional corrosion protection - Through fastening with H, A and C head - Pre-fastening with A head

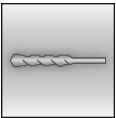
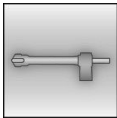

Base material			Load conditions		
					
Concrete (uncracked)	Concrete (cracked)	SFRC	Static / quasi-static	Seismic, C1, C2	Fire resistance
Drilling, cleaning, setting			Other information		
					
Hammer drilled holes	Hollow drill-bit drilling		PROFIS Engineering Software		

Linked Approvals/Certificates and Instructions for use

Approvals/certificates for normal weight concrete without steel fibre and with maximum steel fibre content of 80 kg/m³

Approval no	Application / loading condition	Authority / Laboratory	Date of issue
ETA-20/0867	Static and quasi-static / Seismic/ Fire.	DIBt, Berlin	25-04-2024

HUS4 16 in general and adjustability of HUS4 8 and 10 for SFRC are not in the scope of the ETA.

The instructions for use can be viewed using the link in the instructions for use table or the QR code/link in the Hilti webpage table.

Instructions for use (IFU)



Anchor size	8	10	12	14	16
H, HF	IFU HUS4-H(F)-8	IFU HUS4-H(F)-10	IFU HUS4-H(F)-12	IFU HUS4-H(F)-14	IFU HUS4-H(F)-16
C	IFU HUS4-C-8	IFU HUS4-C-10			
A, AF		IFU HUS4-A-10		IFU HUS4-A-14	
Filling set	IFU Filling set				

Link to Hilti Webpage

HUS4-H	HUS4-HF	HUS4-C	HUS4-A	HUS4-AF
				

Fastener special dimensions

Head configuration

Type	Part	
HUS4-H HUS4-HF	Hexagonal head	
HUS4-C	Countersunk head	
HUS4-A	External thread	 Hilti HUS4-A, size 10 with external thread M12 and size 14 with external thread M16

Fastener dimensions and marking HUS4-H(F)

Anchor size		8	10	12	14	16
Type	HUS4	H, HF	H, HF	H	H, HF	H, HF
Outer diameter of screw thread	d_t [mm]	10,50	12,70	14,70	16,70	18,80
Diameter of integrated washer	d_i [mm]	17,50	20,50	23,60	29,00	32,60
Length of the screw (min/max)	L [mm]	45/150	60/305	70/150	75/150	100/205

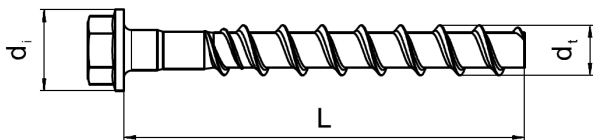

HUS4: Hilti Universal Screw 4th generation
H: Hexagonal head
10: Screw diameter
100: total length of the screw

Fastener dimensions and marking HUS4-C

Anchor size		8	10
Type	HUS4	C	C
Outer diameter of the screw thread	d_t [mm]	10,50	12,70
Countersunk head diameter	d_h [mm]	18,00	21,00
Length of the screw (min/max)	L [mm]	55/85	70/120

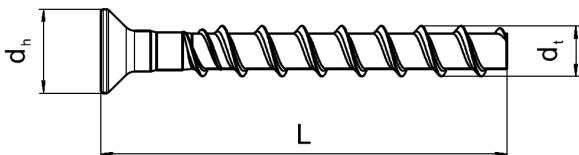

HUS4: Hilti Universal Screw 4th generation
C: Countersunk head
10: Screw diameter
100: total length of the screw

Fastener dimensions and marking HUS4-A(F)

Anchor size		10	14
Type		A, AF	A, AF
Outer diameter of the screw thread	d_t [mm]	12,70	16,70
Diameter of the metric thread	d_M [mm]	M12	M16
Length of the screw (min/max)	L [mm]	120/165	155/205

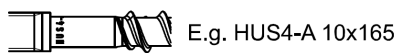
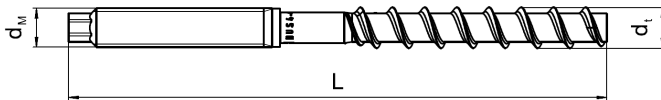

HUS4: Hilti Universal Screw 4th generation

A: Threaded head

10: Screw diameter

100: total length of the screw

8: carbon steel 8.8

K: length of the screw (more info in ETA)

Hilti Filling set

Hilti Filling set dimensions

Hilti filling set size		M10	M12	M16	M20
HUS4-H(F)		8	10	12, 14	16
HUS4-A(F)			10	14	
Filling washer diameter	d_{vs} [mm]	42	44	52	60
Filling washer + spherical washer thickness	h_{fs} [mm]	7	8	9	13

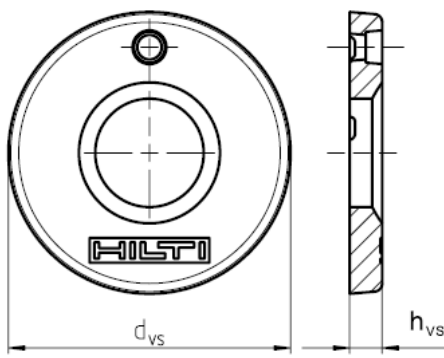

Static and quasi-static loading based on ETA-20/0867. Design according to EN 1992-4

All data in this section applies to:

- Correct setting (See setting instruction)
- For a single anchor
- No edge distance and spacing influence (see table with characteristic distances)
- Characteristic spacing and edge distance for splitting failure apply only for uncracked concrete.
- For cracked concrete only the characteristic spacing and characteristic edge distance for concrete cone failure are decisive
- Minimum base material thickness (see table)
- Embedment depth, as specified in the table of this section
- Anchor material, as specified in the tables of this section
- Concrete C20/25 with and without steel fibre
- Hammer drilled holes
- Recommended loads: With overall partial safety factor for action $\gamma = 1,4$.

For specific design cases refer to [PROFIS Engineering](#).

Design resistance

Type	HUS4	H, HF, C			H, HF, C, A, AF			H			H, HF, A, AF			H, HF	
Anchor size		8			10			12			14			16	
Nominal embedment depth h_{nom} [mm]		h_{nom1}	h_{nom2}	h_{nom3}	h_{nom1}	h_{nom2}	h_{nom3}	h_{nom1}	h_{nom2}	h_{nom3}	h_{nom1}	h_{nom2}	h_{nom3}	h_{nom1}	h_{nom2}
		40	60	70	55	75	85	60	80	100	65	85	115	85	130
Uncracked concrete															
Tension	N_{Rd} [kN]	5,6	10,8	13,8	7,2	14,7	18,4	10,2	16,4	23,4	11,4	17,7	28,8	14,7	30,7
Shear	V_{Rd} [kN]	5,6	15,0	17,5	9,1	23,0	25,6	20,4	31,1	35,9	22,7	35,4	49,6	35,6	58,5
Cracked concrete															
Tension	N_{Rd} [kN]	3,7	7,5	9,6	5,3	10,5	12,9	6,7	11,5	16,4	7,9	12,4	20,2	10,7	21,3
Shear	V_{Rd} [kN]	3,9	15,0	17,5	6,4	21,1	25,6	14,3	22,9	32,8	15,9	24,8	40,4	25,0	49,3

Recommended loads

Type	HUS4	H, HF, C			H, HF, C, A, AF			H			H, HF, A, AF			H, HF	
Anchor size		8			10			12			14			16	
Nominal embedment depth h_{nom} [mm]		h_{nom1}	h_{nom2}	h_{nom3}	h_{nom1}	h_{nom2}	h_{nom3}	h_{nom1}	h_{nom2}	h_{nom3}	h_{nom1}	h_{nom2}	h_{nom3}	h_{nom1}	h_{nom2}
		40	60	70	55	75	85	60	80	100	65	85	115	85	130
Uncracked concrete															
Tension	N_{rec} [kN]	4,0	7,7	9,8	5,2	10,5	13,1	7,3	11,7	16,7	8,1	12,6	20,6	10,5	21,9
Shear	V_{rec} [kN]	4,0	10,7	12,5	6,5	16,5	18,3	14,6	22,2	25,7	16,2	25,3	35,4	25,5	41,8
Cracked concrete															
Tension	N_{rec} [kN]	2,6	5,4	6,9	3,8	7,5	9,2	4,8	8,2	11,7	5,7	8,9	14,4	7,6	15,2
Shear	V_{rec} [kN]	2,8	10,7	12,5	4,5	15,1	18,3	10,2	16,4	23,4	11,4	17,7	28,8	17,8	35,2

Seismic loading based on ETA-20/0867. Design according to EN 1992-4

All data in this section applies to:

- Correct setting (See setting instruction)
- For a single anchor
- No edge distance and spacing influence (see table with characteristic distances)
- Characteristic spacing and edge distance for splitting failure apply only for uncracked concrete.
- For cracked concrete only the characteristic spacing and characteristic edge distance for concrete cone failure are decisive
- Minimum base material thickness (see setting detail table)
- Embedment depth, as specified in the table of this section
- Anchor material, as specified in the tables of this section
- Concrete C20/25 with and without steel fibre for C1 and without steel fibres for C2
- $\alpha_{\text{gap}} = 1,0$ (using Hilti filling set) and $\alpha_{\text{gap}} = 0,5$ (without using Hilti filling set) accordingly
- Hammer drilled holes

For specific design cases refer to [PROFIS Engineering](#).

Design resistance in case of seismic performance category C2

with Hilti filling set							
Type	HUS4	H, HF	H, HF, A, AF			H	H, HF, A, AF
Anchor size		8	10			12	14
Nominal embedment depth	h_{nom} [mm]	$h_{\text{nom}3}$	$h_{\text{nom}1}$	$h_{\text{nom}2}$	$h_{\text{nom}3}$	$h_{\text{nom}3}$	$h_{\text{nom}3}$
		70	55	75	85	100	115
Tension	$N_{\text{Rd,seis}}$ [kN]	1,8	1,7	2,4	3,6	7,6	11,8
Shear	$V_{\text{Rd,seis}}$ [kN]	12,8	12,1		18,5	22,9	34,3
without Hilti filling set							
Type	HUS4	H, HF, C	H, HF, C, A, AF			H	H, HF, A, AF
Anchor size		8	10			12	14
Nominal embedment depth	h_{nom} [mm]	$h_{\text{nom}3}$	$h_{\text{nom}1}$	$h_{\text{nom}2}$	$h_{\text{nom}3}$	$h_{\text{nom}3}$	$h_{\text{nom}3}$
		70	55	75	85	100	115
Tension	$N_{\text{Rd,seis}}$ [kN]	1,8	1,7	2,4	3,6	7,6	11,8
Shear	$V_{\text{Rd,seis}}$ [kN]	4,3	4,3		5,9	9,5	13,8

Design resistance in case of seismic performance category C1

with Hilti filling set											
Type	HUS4	H, HF		H, HF, A, AF		H		H, HF, A, AF		H, HF	
Anchor size		8		10		12		14		16	
Nominal embedment depth	h_{nom} [mm]	$h_{\text{nom}2}$	$h_{\text{nom}3}$	$h_{\text{nom}2}$	$h_{\text{nom}3}$	$h_{\text{nom}2}$	$h_{\text{nom}3}$	$h_{\text{nom}2}$	$h_{\text{nom}3}$	$h_{\text{nom}2}$	$h_{\text{nom}3}$
		60	70	75	85	80	100	85	115	85	130
Tension	$N_{\text{Rd,seis}}$ [kN]	6,4	8,2	9,0	10,9	9,7	13,9	10,5	17,2	5,0	12,7
Shear	$V_{\text{Rd,seis}}$ [kN]	12,8	15,0	17,9	21,4	19,5	27,9	18,0	27,6	21,2	20,2
without Hilti filling set											
Type	HUS4	H, HF, C		H, HF, C, A, AF			H		H, HF, A, AF		
Anchor size		8		10			12		14		
Nominal embedment depth	h_{nom} [mm]	$h_{\text{nom}2}$	$h_{\text{nom}3}$	$h_{\text{nom}2}$	$h_{\text{nom}3}$	$h_{\text{nom}2}$	$h_{\text{nom}3}$	$h_{\text{nom}2}$	$h_{\text{nom}3}$	$h_{\text{nom}2}$	$h_{\text{nom}3}$
		60	70	75	85	80	100	85	115	85	130
Tension	$N_{\text{Rd,seis}}$ [kN]	6,4	8,2	9,0	10,9	9,7	13,9	10,5	17,2	5,0	12,7
Shear	$V_{\text{Rd,seis}}$ [kN]	6,4	7,5	9,0	10,7	9,7	13,9	9,0	13,8	10,6	10,1

Fire loading based on ETA-20/0867. Design according to EN 1992-4

All data in this section applies to:

- Correct setting (See setting instruction)
- For a single anchor
- No edge distance and spacing influence (see table with characteristic distances)
- Characteristic spacing and edge distance for splitting failure apply only for uncracked concrete.
- For cracked concrete only the characteristic spacing and characteristic edge distance for concrete cone failure are decisive
- Minimum base material thickness (see setting detail table)
- Embedment depth, as specified in the table of this section
- Anchor material, as specified in the tables of this section
- Concrete C20/25 with and without steel fibre, Hammer drilled holes
- Partial safety factor for resistance under fire exposure $\gamma_{M,fi} = 1,0$ (in absence of other national regulations)

For specific design cases refer to [PROFIS Engineering](#).

Design resistance

Type	HUS4	H, HF			C			H, HF			C			A		
Anchor size		8						10								
Nominal embedment depth	h_{nom} [mm]	h_{nom1}	h_{nom2}	h_{nom3}	h_{nom1}	h_{nom2}	h_{nom3}	h_{nom1}	h_{nom2}	h_{nom3}	h_{nom1}	h_{nom2}	h_{nom3}	h_{nom1}	h_{nom2}	h_{nom3}
		40	60	70	40	60	70	55	75	85	55	75	85	55	75	85
Fire exposure R30																
Tension	$N_{Rd,fi}$ [kN]	0,8	2,6	2,6	0,5	0,5	0,5	2,0	3,9	4,2	1,0	1,0	1,0	2,0	3,9	4,2
Shear	$V_{Rd,fi}$ [kN]	0,9	2,6	2,6	0,5	0,5	0,5	2,0	3,9	4,2	1,0	1,0	1,0	2,0	4,2	4,2
Fire exposure R60																
Tension	$N_{Rd,fi}$ [kN]	0,8	1,9	1,9	0,4	0,4	0,4	2,0	3,1	3,1	0,9	0,9	0,9	2,0	3,3	3,3
Shear	$V_{Rd,fi}$ [kN]	0,8	1,9	1,9	0,4	0,4	0,4	3,1	3,1	3,1	0,9	0,9	0,9	2,0	3,3	3,3
Fire exposure R90																
Tension	$N_{Rd,fi}$ [kN]	0,8	1,2	1,2	0,3	0,3	0,3	2,0	2,3	2,3	0,7	0,7	0,7	2,0	2,5	2,5
Shear	$V_{Rd,fi}$ [kN]	0,8	1,2	1,2	0,3	0,3	0,3	2,0	2,3	2,3	0,7	0,7	0,7	2,0	2,5	2,5
Fire exposure R120																
Tension	$N_{Rd,fi}$ [kN]	0,7	0,9	0,9	0,2	0,2	0,2	1,5	1,7	1,7	0,6	0,6	0,6	1,6	2,1	2,1
Shear	$V_{Rd,fi}$ [kN]	0,7	0,9	0,9	0,2	0,2	0,2	1,5	1,7	1,7	0,6	0,6	0,6	1,6	2,1	2,1

Design resistance

Type	HUS4	H, HF			H, HF			A			H, HF	
Anchor size		12			14						16	
Nominal embedment depth	h_{nom} [mm]	h_{nom1}	h_{nom2}	h_{nom3}	h_{nom1}	h_{nom2}	h_{nom3}	h_{nom1}	h_{nom2}	h_{nom3}	h_{nom1}	h_{nom2}
		60	80	100	65	85	115	55	75	85	85	130
Fire exposure R30												
Tension	$N_{Rd,fi}$ [kN]	2,4	4,2	6,1	2,9	4,5	7,5	2,9	4,5	7,5	4,6	8,7
Shear	$V_{Rd,fi}$ [kN]	4,9	7,6	7,6	5,9	10,4	10,5	5,9	8,4	8,4	10,6	10,7
Fire exposure R60												
Tension	$N_{Rd,fi}$ [kN]	2,4	4,2	5,8	2,9	4,5	7,5	2,9	4,5	6,8	4,6	8,2
Shear	$V_{Rd,fi}$ [kN]	4,9	5,7	5,8	5,9	7,9	6,0	5,9	6,8	6,8	8,1	8,2
Fire exposure R90												
Tension	$N_{Rd,fi}$ [kN]	2,4	3,9	4,1	2,9	5,6	5,8	2,9	4,5	5,1	4,6	5,9
Shear	$V_{Rd,fi}$ [kN]	3,7	3,9	4,1	5,2	5,6	5,8	5,1	5,1	5,1	5,7	5,9
Fire exposure R120												
Tension	$N_{Rd,fi}$ [kN]	1,9	3,0	3,1	2,3	3,6	4,4	2,3	3,6	4,3	3,7	4,5
Shear	$V_{Rd,fi}$ [kN]	2,8	3,0	3,1	3,9	4,2	4,4	4,3	4,3	4,3	4,3	4,5

Setting information

Setting details size 8-12

Type	HUS4	H, HF, C			H, HF, C, A, AF			H		
Anchor size		8			10			12		
Nominal embedment depth	[mm]	h_{nom1}	h_{nom2}	h_{nom3}	h_{nom1}	h_{nom2}	h_{nom3}	h_{nom1}	h_{nom2}	h_{nom3}
		40	60	70	55	75	85	60	80	100
Effective embedment depth	h_{ef} [mm]	30.6	47.6	56.1	42.5	59.5	68	45.9	62.9	79.9
Nominal diameter of drill bit	d_0 [mm]	8			10			12		
Clearance hole diameter	d_{fmax} [mm]	12			14			16		
Wrench size HEX head	SW1 [mm]	13			15			17		
Wrench size Threaded head	SW1 [mm]	-			8			-		
Wrench size for nut on Threaded head	SW2 [mm]	-			19			-		
Torx size "C" head	TX -	45			50			-		
Countersunk head diameter	d_h [mm]	18			21					
Depth of drill hole for cleaned hole; or uncleaned hole overhead	h_{1min} [mm]	50	70	80	65	85	95	70	90	110
Depth of drill hole for uncleaned hole hammer drilling in wall and floor position	h_{1min} [mm]	66	86	96	85	105	115	94	114	134
Minimum base material thickness	h_{min} [mm]	80	100	120	100	130	140	110	130	150

Minimum distances										
Spacing	s_{min} [mm]	35			40			50		
Edge distance	c_{min} [mm]	35			40			50		
Characteristics distances										
Spacing for splitting failure	$s_{cr,sp}$ [mm]	3 h_{ef}			3,3 h_{ef}			3,3 h_{ef}		
Edge distance for splitting	$c_{cr,sp}$ [mm]	1,5 h_{ef}			1,65 h_{ef}			1,65 h_{ef}		
Spacing for concrete cone failure	$s_{cr,N}$ [mm]				3 h_{ef}					
Edge distance for concrete cone failure	$c_{cr,N}$ [mm]				1,5 h_{ef}					

Setting details size 14-16

Type	HUS4	H, HF, A, AF			H, HF	
Anchor size		14			16	
Nominal embedment depth	[mm]	h_{nom1}	h_{nom2}	h_{nom3}	h_{nom1}	h_{nom2}
		65	85	115	85	130
Effective embedment depth	h_{ef} [mm]	49.3	66.3	91.8	66.6	104.9
Nominal diameter of drill bit	d_0 [mm]	14			16	
Clearance hole diameter	d_{fmax} [mm]	18			20	
Wrench size Hex head	SW1 [mm]	21			24	
Wrench size Threaded head	SW1 [mm]	12			-	
Wrench size for nut on Threaded head	SW2 [mm]	24			-	
Depth of drill hole for cleaned hole; or uncleaned hole overhead	h_{1min} [mm]	75	95	125	95	140
Depth of drill hole for uncleaned hole hammer drilling in wall and floor position	h_{1min} [mm]	103	123	153	-	-



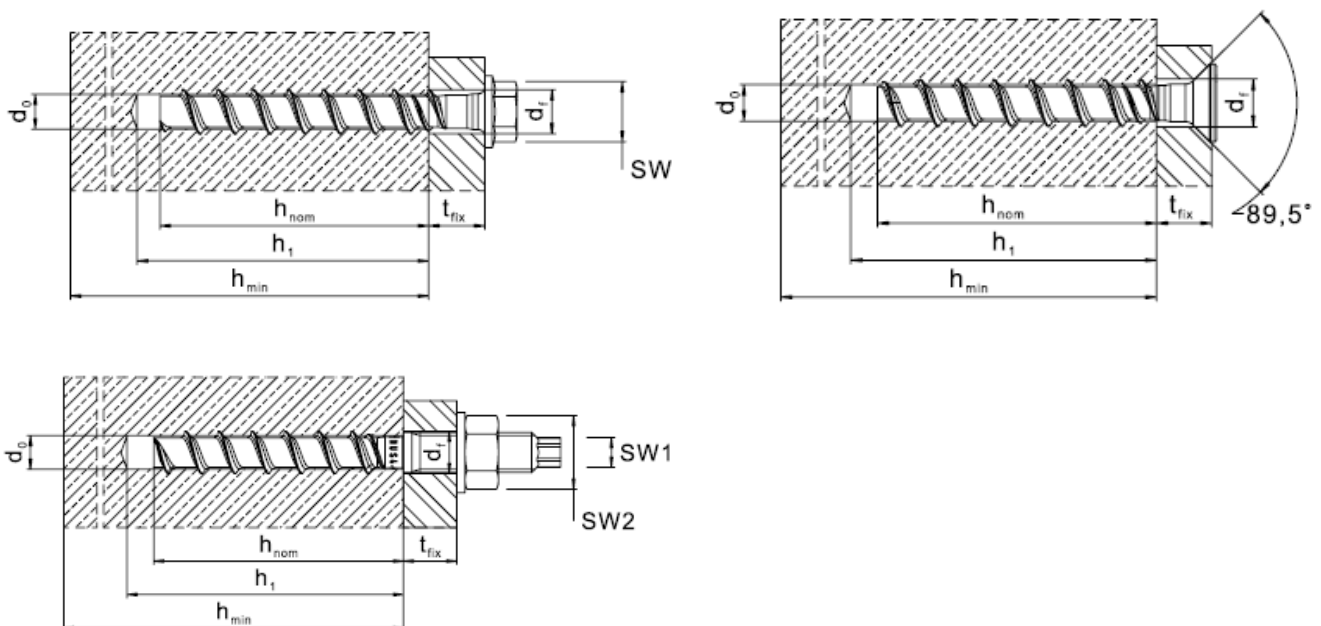

Minimum distances						
Minimum base material thickness	h_{min} [mm]	120	160	200	130	195
Minimum spacing	s_{min} [mm]	60	90			
Minimum edge distance	c_{min} [mm]	60	65			
Characteristics distances						
Spacing for splitting failure	$s_{cr,sp}$ [mm]	$3,3 h_{ef}$				
Edge distance for splitting	$c_{cr,sp}$ [mm]	$1,65 h_{ef}$				
Spacing for concrete cone failure	$s_{cr,N}$ [mm]	$3 h_{ef}$				
Edge distance for concrete cone failure	$c_{cr,N}$ [mm]	$1,5 h_{ef}$				

For spacing (edge distance) smaller than characteristic spacing (characteristic edge distance) the design loads have to be reduced (see system design resistance)



Drilling and Installation equipment

For detailed setting information on installation ,see instructions for use given with the product.

<p>Rotary Hammers (Corded and Cordless)</p>		<p>TE 2 - TE 30</p>
<p>Other tools</p>		<p>Impact wrench- SIW (use recommended socket/driver bit)</p>
		<p>Hammer drill bit TE-CX, TE-C</p>
		<p>Hollow drill bit TE-CD</p>
		<p>Blow out pump</p>



HUS4-HR / HUS4-CR

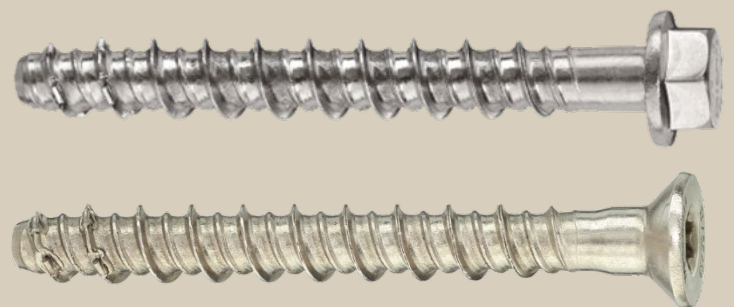

Screw anchor

Product Technical Datasheet
Steel-to-concrete
Update: Sep 24



HUS4-HR / HUS4-CR Screw anchor for use in concrete

High performance screw anchor for single point fastening

Anchor version		Benefits
	HUS4-HR (6-14)	<ul style="list-style-type: none"> - High productivity - less drilling and fewer operations than with conventional anchors - ETA approval for cracked and uncracked concrete - ETA approval for Seismic C1 - Smaller edge and spacing distance - Through fastening with H and C head - Compatible with HUS4 Max capsules for chemical bonding performance - Carbides technology on the tip to ease the setting in tougher concrete materials
	HUS4-CR (6-10)	



Base material	Load conditions
<div style="display: flex; justify-content: space-around;"> <div data-bbox="140 1417 256 1529"> <p>Concrete (uncracked)</p> </div> <div data-bbox="309 1417 426 1529"> <p>Concrete (cracked)</p> </div> </div>	<div style="display: flex; justify-content: space-around;"> <div data-bbox="826 1417 943 1529"> <p>Static / quasi-static</p> </div> <div data-bbox="995 1417 1112 1529"> <p>Seismic, C1</p> </div> <div data-bbox="1165 1417 1281 1529"> <p>Fire resistance</p> </div> </div>

Drilling, cleaning, setting	Other information
<div data-bbox="145 1686 261 1798"> </div> <p>Hammer drilled holes</p>	<div style="display: flex; justify-content: space-around;"> <div data-bbox="826 1686 943 1798"> <p>PROFIS Engineering Software</p> </div> <div data-bbox="995 1709 1112 1776"> <p>Hilti Technical data</p> </div> </div>



Linked Approvals/Certificates and Instructions for use



Approvals/certificates

Approval no	Application / loading condition	Authority / Laboratory	Date of issue
ETA-20/0867	Static and quasi-static / Seismic / Fire	DIBt, Berlin	25-04-2024

Instructions for use(IFU)



Anchor size	6	8	10	14
HR	IFU HUS4-HR-6	IFU HUS4-HR-8	IFU HUS4-HR-10	IFU HUS4-HR-14
CR	IFU HUS4-CR 6	IFU HUS4-CR-8	IFU HUS4-CR-10	-
Filling set	IFU Filling set			

Link to Hilti Webpage

<u>HUS4-HR</u>	<u>HUS4-CR</u>
	

Fastener special dimensions

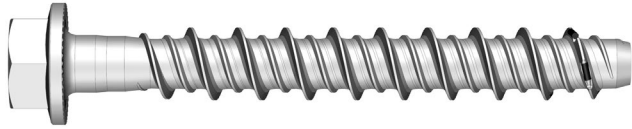
Head configuration

Type		
HUS4-HR	Hexagonal head	
HUS4-CR	Countersunk head	

Fastener dimensions

Type	HUS4-	HR	HR	HR	HR
Anchor size		6	8	10	14
Outer diameter of the screw thread	d_t [mm]	7,55	10,05	12,25	16,56
Diameter of integrated washer	d_i [mm]	17,00	17,50	20,50	30,00
Length of the screw (min/max)	L [mm]	60/70	65/105	75/130	80/135

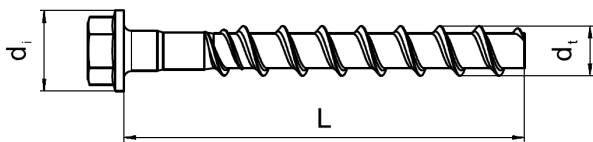

HUS4: Hilti Universal Screw 4th generation

HR: Hexagonal head, stainless steel

10: Nominal screw diameter

x100: total length of the screw

Type	HUS4-	CR	CR	CR
Anchor size		6	8	10
Outer diameter of the screw thread	d_t [mm]	7,55	10,05	12,25
Countersunk head diameter	d_h [mm]	11,00	18,00	21,00
Length of the screw (min/max)	L [mm]	60/70	65/95	75/105

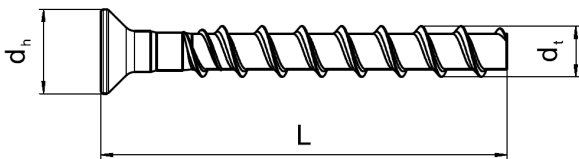

HUS4: Hilti Universal Screw 4th generation

CR: Countersunk head, stainless steel

10: Nominal screw diameter

x100: total length of the screw



Hilti Filling set

Hilti Filling set dimensions

Hilti filling set size			M10	M12	M16
Size of HUS4-HR			8	10	14
Filling washer diameter	d_{vs}	[mm]	42	44	52
Filling washer + spherical washer thickness	h_{fs}	[mm]	7	8	9

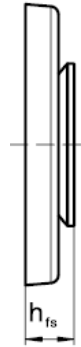
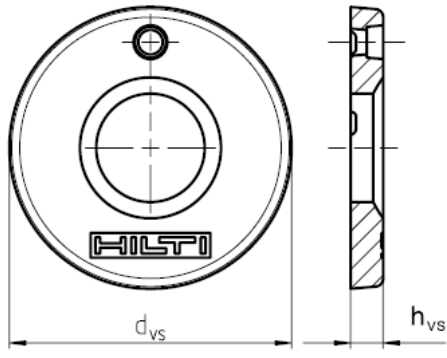

**Static and quasi-static loading based on ETA-20/0867 and Hilti Technical data.
Design according to EN 1992-4**

All data in this section applies to:

- Correct setting (See setting instruction)
- For a single anchor
- Hammer drilled holes
- No edge distance and spacing influence (see table with characteristic distances)
- Characteristic spacing and edge distance for splitting failure apply only for uncracked concrete.
- For cracked concrete only the characteristic spacing and edge distance for concrete cone failure are decisive
- Minimum base material thickness (see table)
- Embedment depth, as specified in the table of this section
- Anchor material, as specified in the tables of this section
- Concrete C20/25
- Recommended loads: With overall partial safety factor for action $\gamma = 1,4$.

For specific design cases refer to [PROFIS Engineering](#).

Design resistance

Type	HUS4-	HR,CR	HR, CR		HR, CR			HR			
Anchor size	6		8		10			14			
Technical data source	ETA		Hilti	ETA	ETA	Hilti	ETA	ETA	ETA	ETA	
Nominal embedment depth h_{nom} [mm]	55		50	60	80	60	70	90	70	110	
Uncracked concrete											
Tension	N_{Rd}	[kN]	4,3	5,0	8,0	8,9	6,7	8,9	16,7	10,2	21,8
Shear	V_{Rd}	[kN]	11,3	15,4	17,3	17,3	20,5	22,0	22,0	24,6	51,3
Cracked concrete											
Tension	N_{Rd}	[kN]	2,4	2,8	5,7	8,3	4,2	6,7	10,7	6,7	13,9
Shear	V_{Rd}	[kN]	10,4	10,8	14,8	17,3	14,3	18,2	22,0	17,2	36,6

Recommended loads

Type	HUS4-	HR,CR	HR, CR		HR, CR			HR			
Anchor size	6		8		10			14			
Technical data source	ETA		Hilti	ETA	ETA	Hilti	ETA	ETA	ETA	ETA	
Nominal embedment depth h_{nom} [mm]	55		50	60	80	60	70	90	70	110	
Uncracked concrete											
Tension	N_{rec}	[kN]	3,1	3,6	5,7	6,3	4,8	6,3	11,9	7,3	15,6
Shear	V_{rec}	[kN]	8,1	11,0	12,4	12,4	14,6	15,7	15,7	17,6	36,7
Cracked concrete											
Tension	N_{rec}	[kN]	1,7	2,0	4,0	6,0	3,0	4,8	7,6	4,8	9,9
Shear	V_{rec}	[kN]	7,4	7,7	10,6	12,4	10,2	13,0	15,7	12,3	26,2

Seismic loading based on ETA-20/0867. Design according to EN 1992-4

All data in this section applies to:

- Correct setting (See setting instruction)
- For a single anchor
- Hammer drilled holes
- No edge distance and spacing influence (see table with characteristic distances)
- Characteristic spacing and edge distance for splitting failure apply only for uncracked concrete.
- For cracked concrete only the characteristic spacing and edge distance for concrete cone failure are decisive
- Minimum base material thickness (see table)
- Embedment depth, as specified in the table of this section
- Anchor material, as specified in the tables of this section
- Concrete C20/25
- $\alpha_{\text{gap}} = 1,0$ (using Hilti filling set) or $\alpha_{\text{gap}} = 0,5$ (without using Hilti filling set) accordingly

For specific design cases refer to [PROFIS Engineering](#).

Design resistance in case of seismic performance category C1

with Hilti filling set				
Type	HUS4-		HR	HR
Anchor size			8	10
Nominal anchorage depth	h_{nom}	[mm]	80	90
Tension	$N_{\text{Rd,seis}}$	[kN]	4,3	8,3
Shear	$V_{\text{Rd,seis}}$	[kN]	7,4	11,9
without Hilti filling set				
Type	HUS4-		HR, CR	HR, CR
Anchor size			8	10
Tension	$N_{\text{Rd,seis}}$	[kN]	4,3	8,3
Shear	$V_{\text{Rd,seis}}$	[kN]	3,7	6,0

Fire loading based on ETA-20/0867. Design according to EN 1992-4

All data in this section applies to:

- Correct setting (See setting instruction)
- For a single anchor
- Hammer drilled holes
- No edge distance and spacing influence (see table with characteristic distances)
- Characteristic spacing and edge distance for splitting failure apply only for uncracked concrete.
- For cracked concrete only the characteristic spacing and edge distance for concrete cone failure are decisive
- Minimum base material thickness (see table)
- Embedment depth, as specified in the table of this section
- Anchor material, as specified in the tables of this section
- Concrete C20/25
- Partial safety factor for resistance under fire exposure $\gamma_{M,fi} = 1,0$ (in absence of other national regulations)

For specific design cases refer to [PROFIS Engineering](#).

Design resistance

Type	HUS4-	HR	CR	HR	CR	HR	CR	HR	CR	HR	CR	HR	CR	
Anchor size	6		8		10		14							
Nominal anchorage depth	h_{nom} [mm]	55	55	60	80	60	80	70	90	70	90	70	110	
Fire Exposure R30														
Tension	N_{Rd} [kN]	1,3	0,2	1,5	3,0	0,8	0,8	2,3	4,0	1,4	1,4	3,0	6,3	
Shear	V_{Rd} [kN]	3,5	0,2	5,2	9,3	0,8	0,8	7,4	14,6	1,4	1,4	6,7	23,6	
Fire Exposure R60														
Tension	N_{Rd} [kN]	1,3	0,2	1,5	3,0	0,6	0,6	2,3	4,0	1,1	1,1	3,0	6,3	
Shear	V_{Rd} [kN]	3,3	0,2	5,2	6,3	0,6	0,6	7,4	12,0	1,1	1,1	6,7	23,6	
Fire Exposure R90														
Tension	N_{Rd} [kN]	1,3	0,2	1,5	3,0	0,5	0,5	2,3	4,0	0,9	0,9	3,0	6,3	
Shear	V_{Rd} [kN]	1,8	0,2	3,2	3,2	0,5	0,5	5,4	5,4	0,9	0,9	6,7	12,2	
Fire Exposure R120														
Tension	N_{Rd} [kN]	1,0	0,1	1,2	1,7	0,4	0,4	1,8	2,4	0,8	0,8	2,4	5,0	
Shear	V_{Rd} [kN]	1,0	0,1	1,7	1,7	0,4	0,4	2,4	2,4	0,8	0,8	5,4	5,4	

Setting information

Setting details

Anchor size		6	8			10			14	
Type	HUS4-	HR, CR	HR, CR			HR, CR			HR	
Nominal embedment depth	h_{nom} [mm]	55	50	60	80	60	70	90	70	110
Effective anchorage depth	h_{ef} [mm]	45	38	47	64	46	54	71	52	86
Nominal diameter of drill bit	d_0 [mm]	6	8			10			14	
Maximum diameter of clearance hole in the fixture	d_f [mm]	9	12			14			18	
Depth drill hole (cleaning)	h_1 [mm]	65	60	70	90	70	80	100	80	120
Depth drill hole (no cleaning)	h_1 [mm]	77	76	86	106	90	100	120	108	148
Wrench size	SW [mm]	13	13			15			21	
Installation torque hand setting	T_{inst} [Nm]	-	35	-	-	45 (only for HR)			65	-
Minimum base material thickness	h_{min} [mm]	100	100	100	120	120			120	140
Minimum distances										
Spacing	s_{min} [mm]	35	45	45	50	50	50	50	50	60
Edge distance	c_{min} [mm]	35	45	45	50	50	50	50	50	60
Characteristics distances										
Spacing for splitting failure	$s_{cr,sp}$ [mm]	135	114	114	192	166	194	256	187	310
Edge distance for splitting failure	$c_{cr,sp}$ [mm]	68	57	71	96	83	97	128	94	155
Spacing for concrete cone failure	$s_{cr,N}$ [mm]	135	114	114	192	166	194	256	187	310
Edge distance for concrete cone failure	$c_{cr,N}$ [mm]	68	57	71	96	83	97	128	94	155

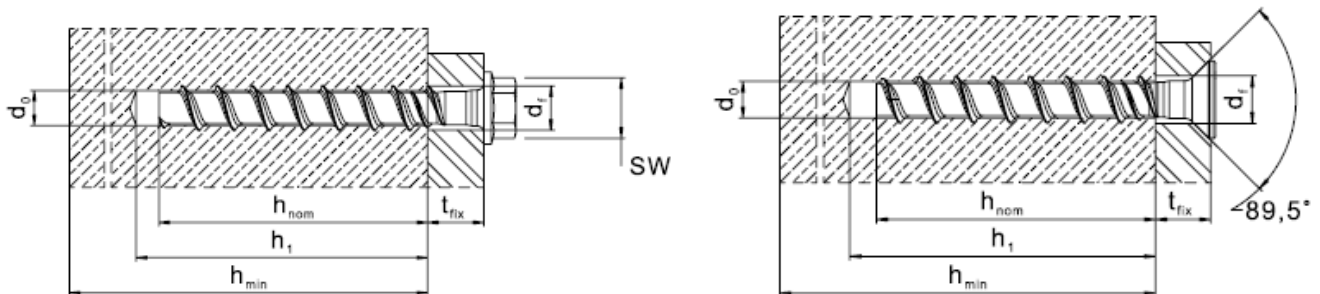

For spacing (edge distance) smaller than characteristic spacing (characteristic edge distance) the design loads have to be reduced (see system design resistance).

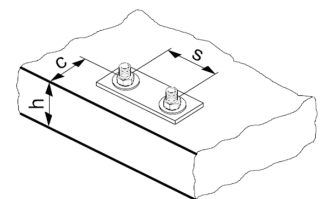

Drilling and Installation equipment

For detailed setting information on installation ,see instructions for use given with the product.

<p>Rotary Hammers (Corded and Cordless)</p>		<p>TE 2 - TE 30</p>
<p>Other tools</p>		<p>Impact wrench- SIW (use recommended socket/driver bit)</p>
		<p>Hammer drill bit TE-CX, TE-C</p>
		<p>Blow out pump</p>



HUS4 Screw anchor

Product Technical Datasheet

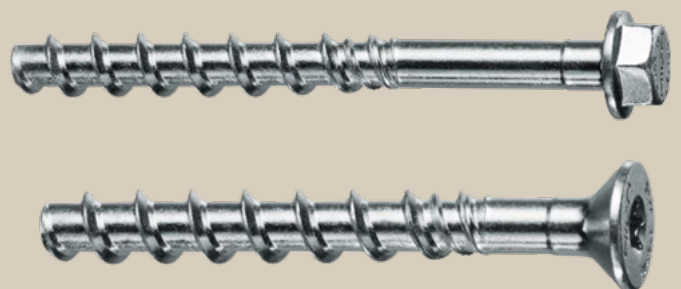

Steel-to-masonry

Update: Sep 24







HUS4 Screw anchor for use in masonry

High performance screw anchor for single point fastening

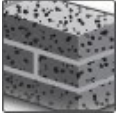
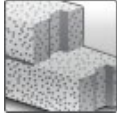
Anchor version	Benefits
 <p>HUS4-H(F) (8-10)*</p>	<ul style="list-style-type: none"> - High productivity - less drilling and fewer operations than with conventional anchors
 <p>HUS4-C (8-10)</p>	<ul style="list-style-type: none"> - HUS4-HF and HUS4-AF with multilayer coatings for additional corrosion protection - Through fastening with H and C head

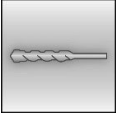

Base material	Load conditions
<div style="display: flex; justify-content: space-around;"> <div data-bbox="140 1211 256 1323">  <p>Solid brick</p> </div> <div data-bbox="309 1211 426 1323">  <p>Autoclaved aerated concrete</p> </div> </div>	<div style="text-align: center;">  <p>Static / quasi-static</p> </div>

Drilling, cleaning, setting	Other information
<div style="text-align: center;">  <p>Hammer drilled holes</p> </div>	<div style="text-align: center;">  <p>Hilti Technical data</p> </div>



Linked Instructions for use

The instructions for use can be viewed using the link in the instructions for use table or the QR code/link in the Hilti webpage table.

Instructions for use (IFU)

Anchor size	8	10
H, HF	IFU HUS4-H(F)-8	IFU HUS4-H(F)-10
C	IFU HUS4-C-8	IFU HUS4-C-10

Link to Hilti Webpage





HUS4-H	HUS4-HF	HUS4-C
		

Basic loading data in solid masonry units as per Hilti Technical data. Design according to EOTA TR 054, design method A.

All data in this section applies to:

- Load values valid for holes drilled with TE rotary hammers (without hammering for PPW)
- Correct anchor setting (see instruction for use, setting details)
- For a single anchor
- Recommended setting machine: SIW 6AT-A
- The ratio of hollow or holes space to solid may not exceed 15 % of a bed joint area
- The brim area around holes must be at least 70mm
- Edge distances, spacing and other influences, see below

HUS4 ,H,C,HF			
Anchor size		8	10
Nominal embedment depth	h_{nom} [mm]	60	75
Drilling diameter for Mz, KS	d_0 [mm]	8	10
Drilling diameter for Vbl, PPW, Leca5®	d_0 [mm]	6	8

Anchor size		8	10
		H, C, HF	H, C, HF
Compressive strength class [N/mm²]		Loads	
	Solid clay brick Mz 12 / 2,0 (EN 771-1)	≥ 12	Tension N_{rec} [kN] 1,4 1,4
			Shear V_{rec} [kN] 3,8 5,5
		≥ 20	Tension N_{rec} [kN] 1,8 1,8
			Shear V_{rec} [kN] 3,7 4,2
	Solid sand-lime brick KS 12 / 2,0 (EN 771-2)	≥ 12	Tension N_{rec} [kN] 3,7 4,2
			Shear V_{rec} [kN] 4,6 5,7
		≥ 20	Tension N_{rec} [kN] 4,8 5,4
			Shear V_{rec} [kN] 1,0 1,6
	Aerated concrete PPW 6-0,4 (EN 771-4)	≥ 6	Tension N_{rec} [kN] 1,0 1,6
			Shear V_{rec} [kN] 1,3 1,5
	Solid lightweight concrete brick Vbl 5, 2DF (EN 771-3) Solid lightweight concrete brick Leca5® Murblock 19 (EN 771-3)	≥ 5	Tension N_{rec} [kN] 2,0 2,0
			Shear V_{rec} [kN] 2,1 2,8
	Solid lightweight concrete brick Vbl 6, 2DF (EN 771-3) Solid lightweight concrete brick Leca5® Murblock 19 (EN 771-3)	≥ 5	Tension N_{rec} [kN] 2,0 2,0
			Shear N_{rec} [kN] 2,0 2,0

Brick code	Brick name	Size [mm]	t_o [mm]	t_i [mm]	a [mm]	f_b [N/mm²]	ρ [kg/dm³]
SC3	Solid clay brick Mz 12 / 2,0 (EN 771-1)	l: ≥ 240 b: ≥ 115 h: ≥ 113	-	-	-	12 20	2,0
SCS1	Solid sand-lime brick KS 12 / 2,0 (EN 771-2)	l: ≥ 240 b: ≥ 115 h: ≥ 113	-	-	-	12 20	2,0
SC5	Aerated concrete PPW 6-0,4 (EN 771-4)						
SLWC1	Solid lightweight concrete brick Vbl 5 2DF (EN 771-3) Solid lightweight concrete brick Leca5® Murblock 19 (EN 771-3)	l: ≥ 240 b: ≥ 115 h: ≥ 113	-	-	-	4 6	0,9

Permissible anchor location in brick and block walls

Edge distance and spacing influence

- The technical data for HUS4 anchors are reference loads for MZ 12, KS 12, Vbl 6, PPW 6 and Leca5®. Due to the large variation of natural stone laid bricks, on site anchor testing is recommended to validate technical data
- The HUS4 anchor was installed and tested in center of solid bricks as shown. The HUS4 anchor was not tested in the mortar joint between solid bricks or in hollow bricks, however a load reduction is expected
- For brick walls where anchor position in brick can not be determined, 100 % anchor testing is recommended
- Distance from free edge to solid masonry (Mz, KS and light weight concrete) units $\geq 200\text{mm}$
- Distance from free edge to solid masonry (autoclaved aerated gas concrete) units $\geq 170\text{mm}$
- The minimum distance to horizontal and vertical mortar joint (c_{\min}) is stated in drawing below
- Minimum anchor spacing (s_{\min}) in one brick/block is $\geq 80\text{ mm}$

Limits

- All data is for multiple use for non-structural applications
- Plaster, graveling, lining or levelling courses are regarded as non-bearing and may not be taken into account for the calculation of embedment depth
- The decisive resistance to tension loads is the lower value of N_{rec} (brick breakout, pull out) and $N_{\text{max,pb}}$ (pull out of one brick)

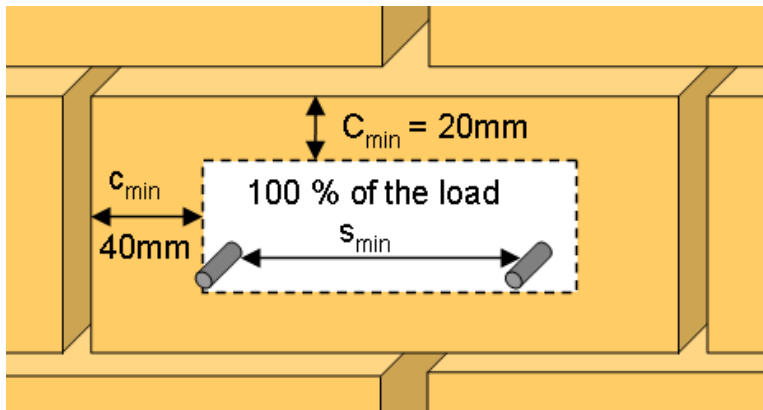

Design tension and shear resistance – Pull out / Pushing out of one brick failure modes

Pull out of one brick (tension):

$$N_{\text{Rd,pb}} = 2 \cdot l \cdot b \cdot (0,5 \cdot f_{\text{vko}} + 0,4 \cdot \sigma_d) / (2,5 \cdot 1000) \quad [\text{kN}]$$

$$N_{\text{Rd,pb}} = (2 \cdot l \cdot b \cdot (0,5 \cdot f_{\text{vko}} + 0,4 \cdot \sigma_d) + b \cdot h \cdot f_{\text{vko}}) / (2,5 \cdot 1000) \quad [\text{kN}]$$

* this equation is applicable if the vertical joints are filled

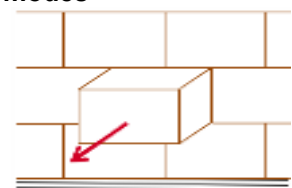

Pushing out of one brick (shear):

$$V_{\text{Rd,pb}} = 2 \cdot l \cdot b \cdot (0,5 \cdot f_{\text{vko}} + 0,4 \cdot \sigma_d) / (2,5 \cdot 1000) \quad [\text{kN}]$$

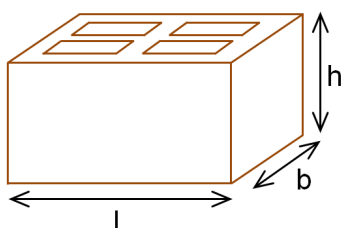
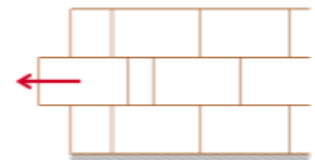

σ_d = design compressive stress perpendicular to the shear (N/mm²)

f_{vko} = initial shear strength according to EN 1996-1-1, Table 3.4

Brick type	Mortar strength	f_{vko} [N/mm ²]
Clay brick	M2,5 to M9	0,20
	M10 to M20	0,30
All other types	M2,5 to M9	0,15
	M10 to M20	0,20

Drilling and Installation equipment

For detailed setting information on installation ,see instructions for use given with the product.

<p>Rotary Hammers (Corded and Cordless)</p>		<p>TE 2 - TE 30</p>
<p>Other tools</p>		<p>Impact wrench- SIW (use recommended socket/driver bit)</p>
		<p>Hammer drill bit TE-CX, TE-C</p>
		<p>Blow out pump</p>



HUS4-HR / HUS4-CR

Screw anchor

Product Technical Datasheet
Steel-to- masonry
Update: Sep 24

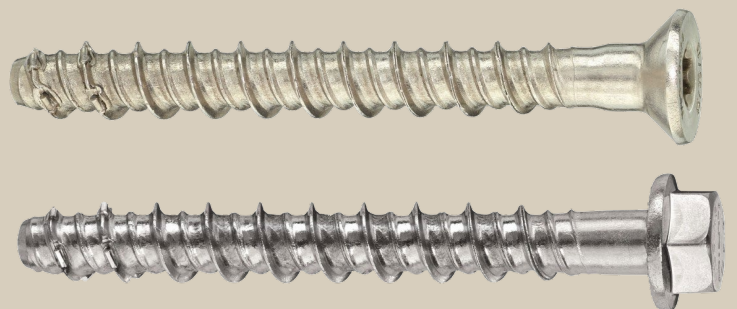



HUS4-HR / HUS4-CR Screw anchor for use in masonry

High performance screw anchor for single point fastening

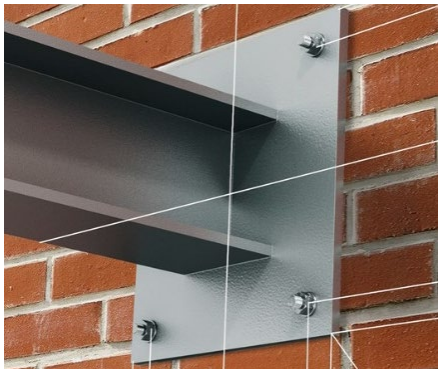
Anchor version		Benefits
	HUS4-HR (6-10)	- High productivity - less drilling and fewer operations than with conventional anchors
	HUS4-CR (6-10)	- Smaller edge and spacing distance - Through fastening with H and C head

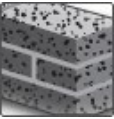
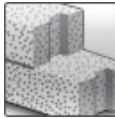
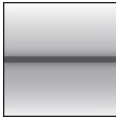

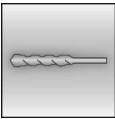
Base material		Load conditions
		
Solid brick	Autoclaved aerated concrete	Static / quasi-static

Drilling, cleaning, setting	Other information
	
Hammer drilled holes	Hilti Technical data



Linked Instructions for use

Instructions for use (IFU)



Anchor size	6	8	10
HR	IFU HUS4-HR-6	IFU HUS4-HR-8	IFU HUS4-HR-10
CR	IFU HUS4-CR 6	IFU HUS4-CR-8	IFU HUS4-CR-10

Link to Hilti Webpage

<u>HUS4-HR</u>	<u>HUS4-CR</u>
	

Fastener special dimensions

Head configuration

Type		
HUS4-HR	Hexagonal head	
HUS4-CR	Countersunk head	

Fastener dimensions

Type	HUS4-	HR	HR	HR
Anchor size		6	8	10
Outer diameter of the screw thread	d_t [mm]	7,55	10,05	12,25
Diameter of integrated washer	d_i [mm]	17,00	17,50	20,50
Length of the screw (min/max)	L [mm]	60/70	65/105	75/130

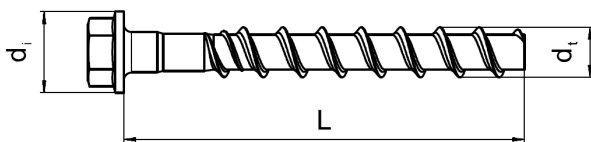

HUS4: Hilti Universal Screw 4th generation

HR: Hexagonal head, stainless steel

10: Nominal screw diameter

x100: total length of the screw

Type	HUS4-	CR	CR	CR
Anchor size		6	8	10
Outer diameter of the screw thread	d_t [mm]	7,55	10,05	12,25
Countersunk head diameter	d_h [mm]	11,00	18,00	21,00
Length of the screw (min/max)	L [mm]	60/70	65/95	75/105

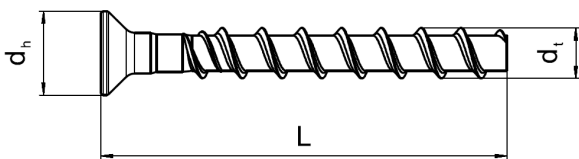

HUS4: Hilti Universal Screw 4th generation

CR: Countersunk head, stainless steel

10: Nominal screw diameter



x100: total length of the screw

**Basic loading data in solid masonry units based on Hilti technical data.
Design according to EOTA TR 055, design method A**

All data in this section applies to:

- Load values valid for holes drilled with TE rotary hammers in hammering mod
- For a single anchor
- Correct anchor setting (see instruction for use, setting details)
- The core/material ratio may not exceed 15 % of a bed joint area
- The brim area around holes must be at least 70mm
- Edge distances, spacing and other influences, see below

Recommended loads for HUS4-HR / HUS4-CR

Anchor size			6	8	10
Nominal embedment depth		h_{nom} [mm]	55	60	70
Brick type	Compressive strength, f_b	Loads			
	Solid clay brick Mz 12/2,0 DIN 105 / EN 771-1 ≥ 12 [N/mm ²]	Tension N_{rec} [kN]	0,9	1,0	1,1
		Shear V_{rec} [kN]	1,4	2,0	2,3
	Solid sand-lime brick Mz 12/2,0 DIN 106/EN 771-2 ≥ 12 [N/mm ²]	Tension N_{rec} [kN]	0,6	0,6	1,0
		Shear V_{rec} [kN]	0,9	1,1	1,7
	Aerated concrete PPW 6-0,4 DIN 4165/EN 771-4 ≥ 6 [N/mm ²]	Tension N_{rec} [kN]	0,2	0,2	0,4
		Shear V_{rec} [kN]	0,4	0,4	0,9

Permissible anchor location in brick and block walls

Edge distance and spacing influence

- The technical data for HUS4-HR anchors are reference loads for MZ 12 and KS 12. Due to the large variation of natural stone solid bricks, on site anchor testing is recommended to validate technical data
- The HUS4-HR anchor was installed and tested in center of solid bricks as shown. The HUS4-HR anchor was not tested in the mortar joint between solid bricks or in hollow bricks, however a load reduction is expected
- For brick walls where anchor position in brick can not be determined, 100 % anchor testing is recommended
- Distance to free edge free edge to solid masonry (Mz and KS) units ≥ 170 mm
- Distance to free edge free edge to solid masonry (autoclaved aerated gas concrete) units ≥ 170 mm
- The minimum distance to horizontal and vertical mortar joint (c_{min}) is started in drawing below
- Minimum anchor spacing (s_{min}) in one brick/block is $\geq 2 \cdot c_{min}$

Limits

- Applied load to individual bricks may not exceed 1,0 kN without compression or 1,4 kN with compression
- All data is for multiple use for non-structural applications
- Plaster, graveling, lining or levelling courses are regarded as non-bearing and may not be taken into account for the calculation of embedment depth

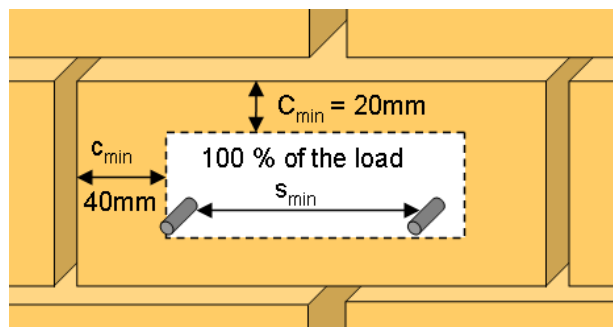

Drilling and Installation equipment

For detailed setting information on installation ,see instructions for use given with the product.

<p>Rotary Hammers (Corded and Cordless)</p>		<p>TE 2 - TE 30</p>
<p>Other tools</p>		<p>Torque tool (use recommended socket/driver bit/required attachment)</p>
		<p>Hammer drill bit TE-CX, TE-C</p>
		<p>Blow out pump</p>



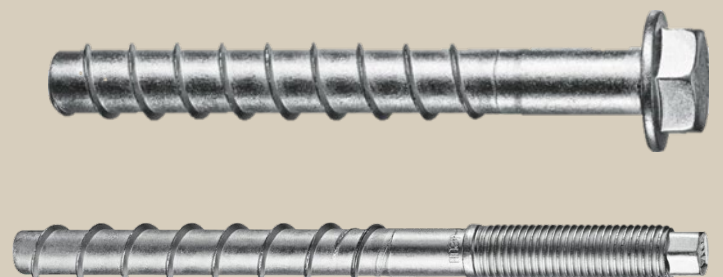

HUS4 Screw anchor

Product Technical Datasheet
Temporary fastening
Steel-to-concrete
Update: Sep 24



HUS4 Screw anchor for use in concrete temporary fastening

High performance screw anchor for single point fastening

Anchor version	Benefits
 <p>HUS4-H (8-16)</p>	<ul style="list-style-type: none"> - High productivity - less drilling and fewer operations than with conventional anchors - Smaller edge and spacing distance - aBG (DIBt) approval for reusability in fresh concrete ($f_{ck, cube} = 10/15/20/25$ N/mm²) for temporary applications
 <p>HUS4-A (10-14)</p>	<ul style="list-style-type: none"> - Three embedment depths - Through fastening with H, A head - Pre-fastening with A head

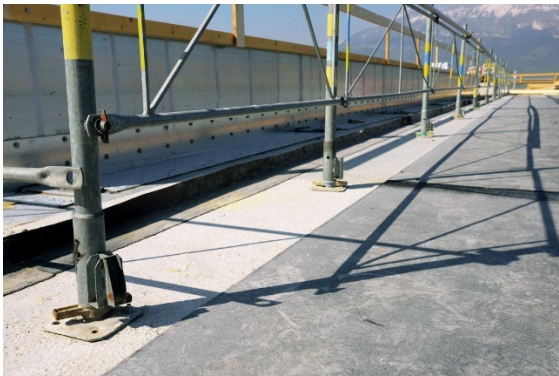

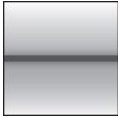
Base material	Load conditions
<div style="display: flex; justify-content: space-around;"> <div data-bbox="140 1296 256 1413"> <p>Concrete (uncracked)</p> </div> <div data-bbox="309 1296 426 1413"> <p>Concrete (cracked)</p> </div> </div>	<div style="text-align: center;">  <p>Static / quasi-static</p> </div>

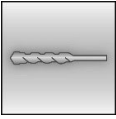
Drilling, cleaning, setting	Other information
<div style="text-align: center;">  <p>Hammer drilled holes</p> </div>	



Linked Approvals/Certificates and Instructions for use

Approvals/certificates



Approval no	Application / loading condition	Authority / Laboratory	Date of issue	Date of expiry
Z-21.8-2137	aBG for temporary fastening	DIBt, Berlin	21-12-2021	21-12-2026

The instructions for use can be viewed using the link in the instructions for use table or the QR code/link in the Hilti webpage table.

Instructions for use (IFU)

Anchor size	8	10	12	14	16
H	IFU HUS4-H-8	IFU HUS4-H-10	IFU HUS4-H-12	IFU HUS4-H-14	IFU HUS4-H-16
A		IFU HUS4-A-10		IFU HUS4-A-14	

Link to Hilti Webpage

HUS4-H	HUS4-A
	

Basic loading data for temporary application in standard and fresh concrete <28 days old, based on DIBt approval Z-21.8-2137. Design according to EN 1992-4 (Method C).

All data in this section applies to the following conditions:

- Strength class, $f_{ck,cube} \geq 10 \text{ N/mm}^2$
- Temporary use
- Screw is reusable, before each usage it must be checked according to Hilti instruction for use with the suited tube Hilti HRG
- Design resistance is valid for single anchor only
- Design resistance is valid for all load directions and valid for both cracked and uncracked concrete
- Minimum base material thickness
- No edge distance and spacing influence (provided $c \geq c_{min}$ and $s \geq s_{min}$)

Anchor size		HUS4-H (A)	8		10			12			14			16	
Nominal embedment depth h_{nom} [mm]			h_{nom2}	h_{nom3}	h_{nom1}	h_{nom2}	h_{nom3}	h_{nom1}	h_{nom2}	h_{nom3}	h_{nom1}	h_{nom2}	h_{nom3}	h_{nom1}	h_{nom2}
			60	70	55	75	85	60	80	100	65	85	115	85	130
Tension	$f_{ck,cube} \geq 10 \text{ N/mm}^2$	N_{Rd} [kN]	3,3	4,7	3,3	5,3	6,3	2,6	5,4	7,8	4,4	7,0	12,3	5,5	12,6
	$f_{ck,cube} \geq 15 \text{ N/mm}^2$	N_{Rd} [kN]	4,0	5,7	4,0	6,4	7,8	3,5	7,3	10,6	5,4	8,5	15,0	7,5	17,0
Shear	$f_{ck,cube} \geq 20 \text{ N/mm}^2$	V_{Rd} [kN]	4,6	6,6	4,7	7,4	9,0	4,0	8,4	12,2	6,2	9,9	17,3	8,7	19,7
	$f_{ck,cube} \geq 25 \text{ N/mm}^2$	V_{Rd} [kN]	5,1	7,4	5,3	8,3	10,1	4,5	9,4	13,6	6,9	11,1	19,3	9,7	22,0

Setting information

Setting details

Anchor size	HUS4-H (A)	8		10			12			14			16	
		h_{nom2}	h_{nom3}	h_{nom1}	h_{nom2}	h_{nom3}	h_{nom1}	h_{nom2}	h_{nom3}	h_{nom1}	h_{nom2}	h_{nom3}	h_{nom1}	h_{nom2}
Nominal embedment depth	h_{nom} [mm]	60	70	55	75	85	60	80	100	65	85	115	85	130
Drilling depth	h_{1min} [mm]	70	80	65	85	95	70	90	110	75	95	125	95	140
Option 1														
Minimum edge distance	c_{1min} [mm]	80	100	75	100	115	65	105	135	85	115	180	105	180
Minimum base material thickness	h_{min} [mm]	120	150	115	150	175	110	160	205	130	175	255	160	220
Option 2														
Minimum edge distance	c_{1min} [mm]	85	110	85	120	135	65	120	160	100	135	300	115	215
Minimum base material thickness	h_{min} [mm]	100	120	100	130	140	110	130	150	120	160	200	130	195
Minimum edge distance	c_{2min} [mm]	1,5 c_1												
Minimum spacing	s_{min} [mm]	3,0 c_1												
Check gauge		HRG 8		HRG 10			HRG 12			HRG 14			HRG 16	
Diameter of clearance hole for H head	d_{fmax} [mm]	14		16			20			22			24	
Diameter of clearance hole for A head	d_{fmax} [mm]	-		14			-			18			-	
Socket size H head	SW	13		15			17			21			24	
Socket size A head	SW1 (SW2)	-		8 (17)			-			12 (24)			-	

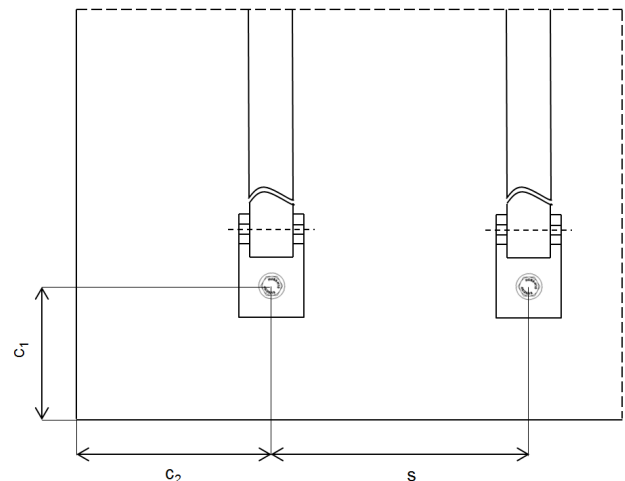
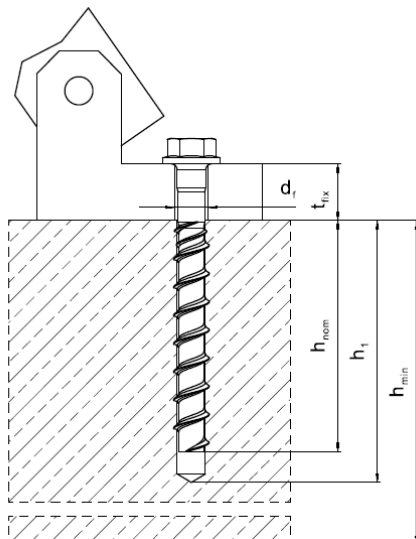
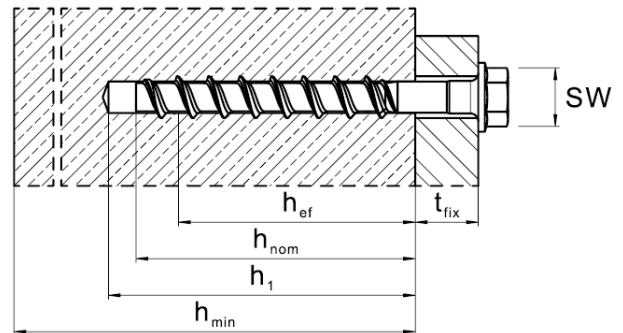
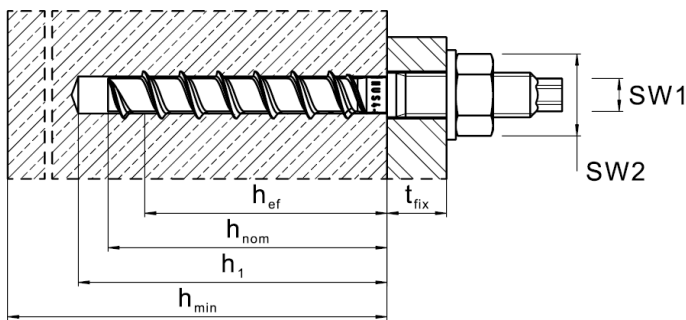

Drilling and Installation equipment

For detailed setting information on installation ,see instructions for use given with the product.

<p>Rotary Hammers (Corded and Cordless)</p>		<p>TE 2 - TE 30</p>
<p>Other tools</p>		<p>Impact wrench- SIW (use recommended socket/driver bit)</p>
		<p>Check gauge</p>
		<p>Hammer drill bit TE-CX TE-C</p>
		<p>Blow out pump</p>



HUS4 Screw anchor

Product Technical Datasheet

Hollow core slabs

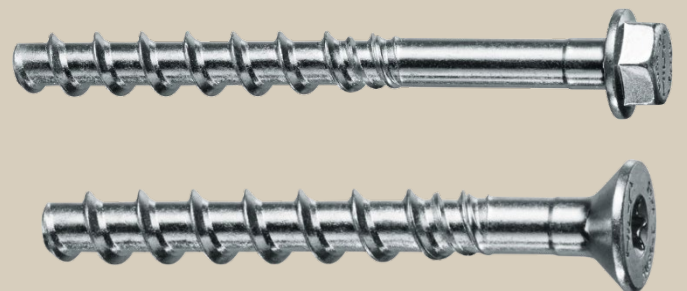

Steel-to-concrete

Update: Sep 24









HUS4 Screw anchor for use in Hollow core slabs

High performance screw anchor for single point fastening

Anchor version		Benefits
	<p>HUS4-H(F) (8-10)*</p>	<ul style="list-style-type: none"> - High productivity - less drilling and fewer operations than with conventional anchors
	<p>HUS4-C (8-10)</p>	<ul style="list-style-type: none"> - Smaller edge and spacing distance - Three embedment depths for maximum design flexibility and flexible design for concrete cone capacity
		<ul style="list-style-type: none"> - HUS4-HF with multilayer coatings for additional corrosion protection - Through fastening with H-and C head

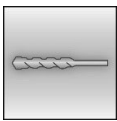

Base material		Load conditions	
 Concrete (uncracked)	 Hollow core slabs	 Static / quasi-static	 Fire resistance
Drilling, cleaning, setting		Other information	
 Hammer drilled holes		 Hilti Technical data	



Linked Approvals/Certificates and Instructions for use

Approvals/certificates

Approval no	Application / loading condition	Authority / Laboratory	Date of issue
GS 6.1/21-041-3	Fire assessment for prestressed HCS	MFPA, Leipzig	29-06-2022

The instructions for use can be viewed using the link in the instructions for use table or the QR code/link in the Hilti webpage table.

Instructions for use (IFU)

Anchor size	8	10
H, HF	IFU HUS4-H(F)-8	IFU HUS4-H(F)-10
C	IFU HUS4-C-8	IFU HUS4-C-10

Link to Hilti Webpage

HUS4-H	HUS4-HF	HUS4-C
		

Basic loading data and design in pre-stressed Hollow core slab (HCS) for permanent fastening based on Hilti Technical data.

All data in this section applies to

- Correct anchor setting (see instruction for use, setting details)
- Recommended drilling machine: TE2 A22, recommended setting machine: SIW 6AT-A
- For a single anchor
- No edge distance and spacing influence
- Ratio core width / web thickness $\leq 5,3$
- Concrete from C30/37 to C45/55
- Recommended loads: With overall partial safety factor for action $\gamma = 1,4$.

Design resistance

Anchor size	HUS4	8					10				
		C30/37		C45/55			C30/37		C45/55		
Nominal embedment depth	h_{nom} [mm]	d_b+10									
Drilling depth	d_0 [mm]	$\geq h_{nom} + 10$									
Bottom flange thickness	d_{bmin} [mm]	30	35	40	35	40	30	35	40	35	40
Tension	N_{Rd} [kN]	1,3	3,2	3,9	4,0	4,8	1,3	3,2	3,9	4,0	4,8
Shear	V_{Rd} [kN]	1,3	6,2	7,6	7,6	9,3	1,3	6,8	8,3	8,3	10,1

Recommended loads

Anchor size	HUS4	8					10				
		C30/37		C45/55			C30/37		C45/55		
Nominal embedment depth	h_{nom} [mm]	d_b+10									
Drilling depth	d_0 [mm]	$\geq h_{nom} + 10$									
Bottom flange thickness	d_{bmin} [mm]	30	35	40	35	40	30	35	40	35	40
Tension	N_{rec} [kN]	0,95	2,3	2,8	2,9	3,4	0,95	2,3	2,8	2,9	3,4
Shear	V_{rec} [kN]	0,95	4,4	5,4	5,4	6,6	0,95	4,9	5,9	5,9	7,2

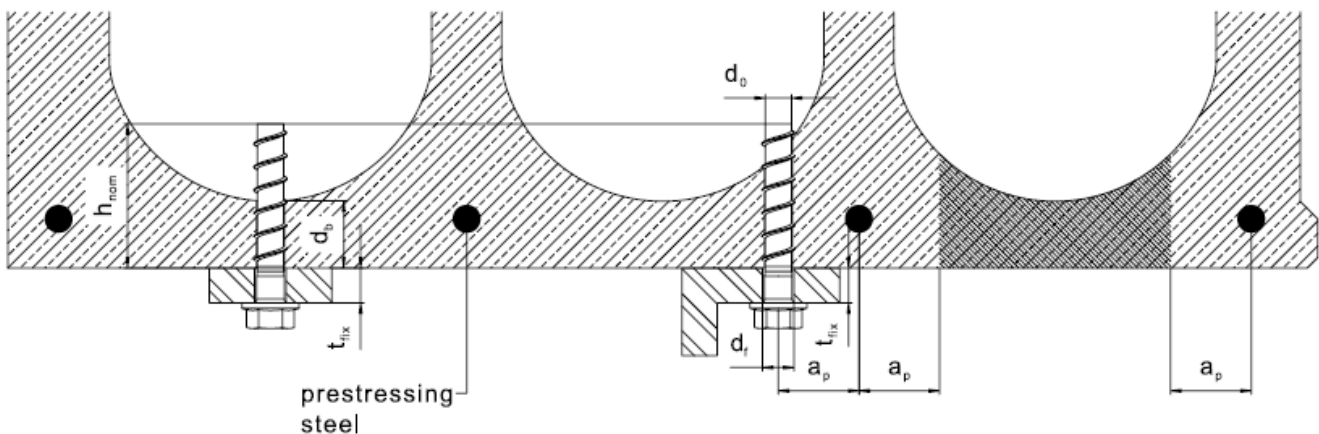

Fire resistance and design in pre-stressed Hollow core slab (HCS) for permanent fastening based on Hilti Technical data.

All data in this section applies to

- Correct anchor setting (see instruction for use, setting details)
- Recommended drilling machine: TE2 A22, recommended setting machine: SIW 6AT-A
- No edge distance and spacing influence
- For a single anchor
- Ratio core width / web thickness $\leq 5,3$
- Concrete from C30/37
- Partial safety factor for resistance under fire exposure $\gamma_{M,fi} = 1,0$ (in absence of other national regulations)

Design resistance

Anchor size		HUS4	8	10	8	10
Concrete strength		C30/37				
Nominal embedment depth	h_{nom} [mm]	$d_b + 10$				
Hollow core slab height	h_{min} [mm]	265			380	
Bottom flange thickness	d_{bmin} [mm]	35			40	
Fire exposure R30	$F_{Rd,fi}$ [kN]	0,26	0,60	0,76	0,80	
Fire exposure R60	$F_{Rd,fi}$ [kN]	0,26	0,60	0,76	0,80	
Fire exposure R90	$F_{Rd,fi}$ [kN]	0,26	0,60	0,76	0,80	
Fire exposure R120	$F_{Rd,fi}$ [kN]	0,26	0,60	0,61	0,80	

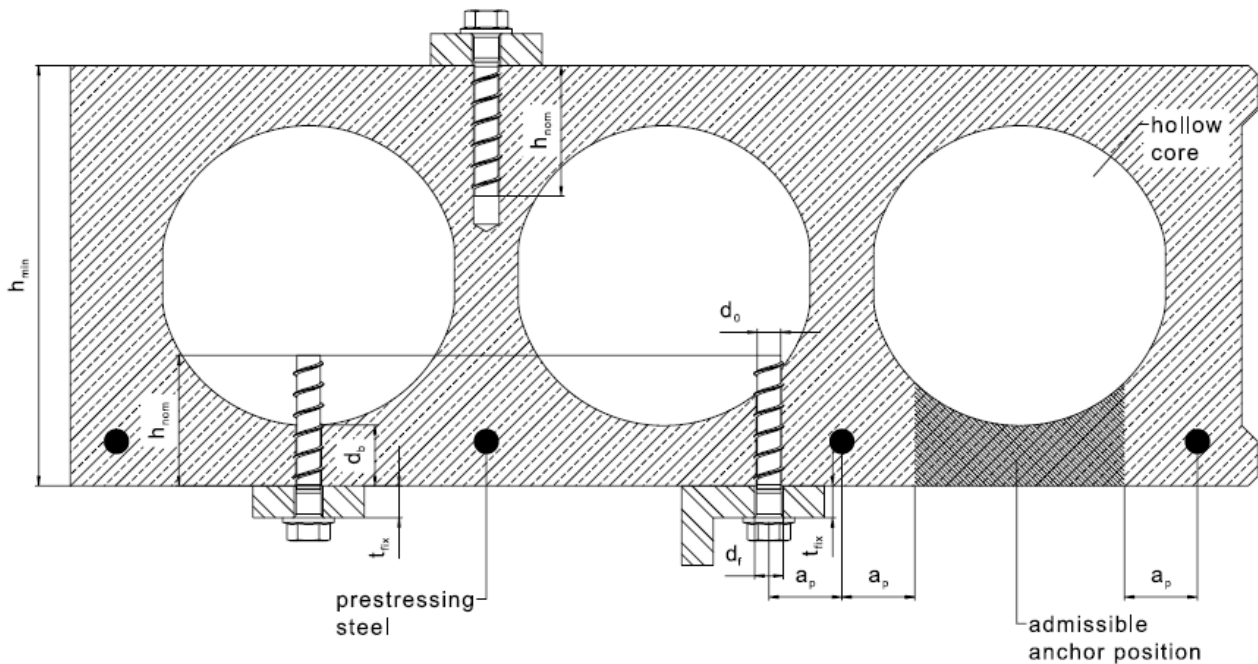

Anchor size		8	10
Type	HUS4	C, H, HF	C, H, HF, A, AF
Minimum and characteristic spacing	$s_{min} = s_{cr}$ [mm]	$4 * d_b$	
Minimum and characteristic edge distance	$c_{min} = c_{cr}$ [mm]	$4 * d_b$	
Minimum group distance	a_{min} [mm]	$4 * d_b$	

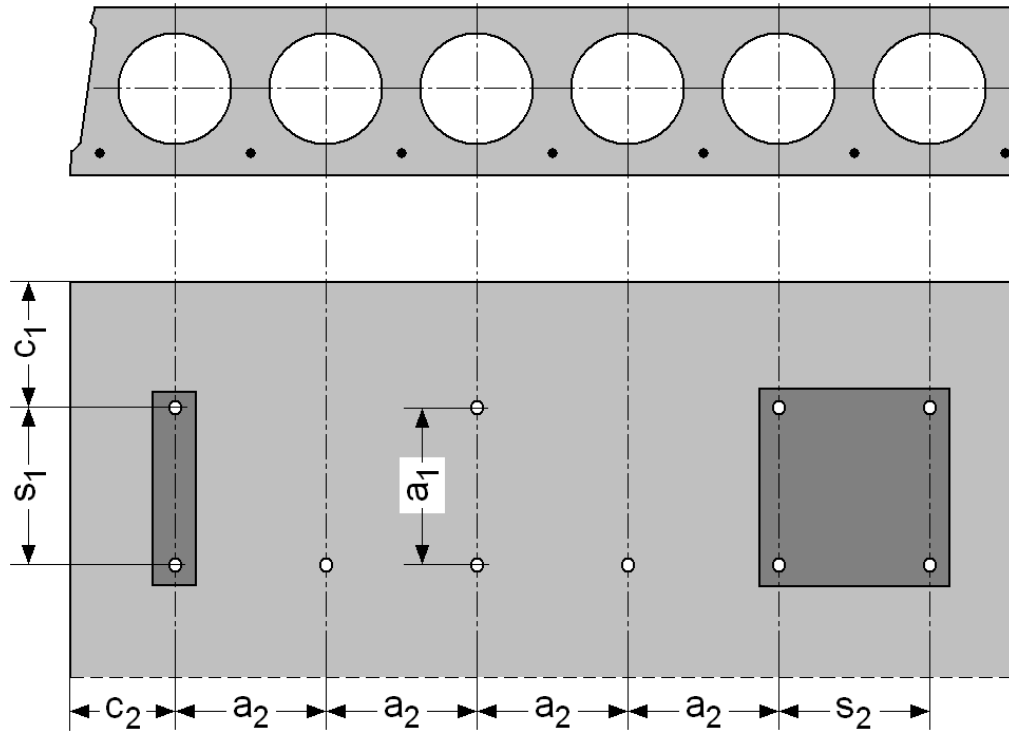

Anchor Type	Size [mm]	Length [mm]	$d_b=30$ [mm]		$d_b=35$ [mm]		$d_b=40$ [mm]		$d_b=50$ [mm]	
			$t_{fix,min}$ [mm]	$t_{fix,max}$ [mm]	$t_{fix,min}$ [mm]	$t_{fix,max}$ [mm]	$t_{fix,min}$ [mm]	$t_{fix,max}$ [mm]	$t_{fix,min}$ [mm]	$t_{fix,max}$ [mm]
HUS4-H(F)	8	45	5	10	5	5	-	-	-	-
		55	15	20	15	15	-	-	-	-
		65	5	30	5	25	5	20	5	10
		75	10	40	10	35	10	30	10	20
		85	20	50	20	45	20	40	20	30
		100	35	65	35	60	35	55	35	45
		120	55	85	55	80	55	75	55	65
		150	85	115	85	110	85	105	85	95
HUS4-H(F)	10	60	5	20	5	15	5	10	-	-
		70	15	30	15	25	15	20	-	-
		80	5	40	5	35	5	30	5	20
		90	10	50	10	45	10	40	10	30
		100	20	60	20	55	20	50	20	40
		110	30	70	30	65	30	60	30	50
		130	50	90	50	85	50	80	50	70
		150	70	110	70	105	70	100	70	90

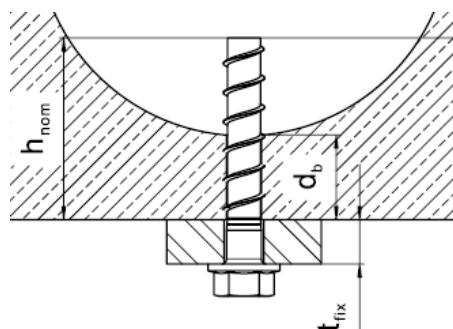

Basic loading data in pre-stressed Hollow core slab (HCS) for temporary fastening

All data in this section applies to

- Correct setting (see setting instruction)
- for single anchor
- Verification of wear of the screw with HUS HRG check gauge is needed
- No edge distance and spacing influence
- Ratio core width / web thickness $w/e \leq 5,3$
- Concrete C30/37 to C50/60, uncracked
- With overall partial safety factor for action $\gamma = 1,4$.

Loads recommendation applies also for installation from top position with no restriction of the admissible anchor position in case of no reinforcement in the related area.

Installation position for temporary fastening in HCS:

- Top position of the slab is allowed.
- Anchor to be installed within position of ± 10 mm of the thickest section of the solid part.

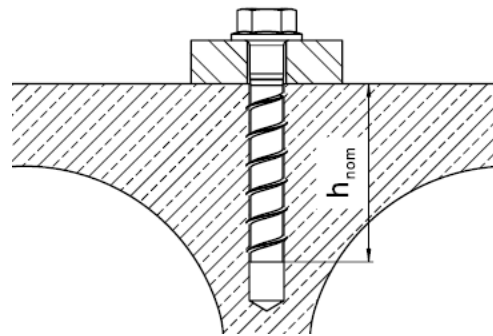
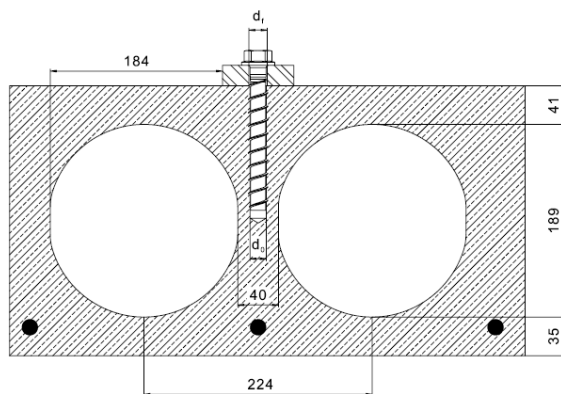

Design resistance: Concrete C30/37

Type	HUS4	A, AF, C, H, HF			H			A, AF, H, HF		
Anchor size		10			12			14		
Nominal embedment depth	h_{nom} [mm]	55	75	85	60	80	100	65	85	115
Drill hole depth	h_{1min} [mm]	$h_{nom} + 10$ mm								
Tension	N_{Rd} [kN]	9,6	14,7	15,8	11,2	16,0	20,1	12,1	17,7	25,1
Shear	V_{Rd} [kN]	10,0	16,7	17,6	15,5	18,8	22,2	17,0	20,9	24,7

Recommended load: Concrete C30/37

Type	HUS4	A, AF, C, H, HF			H			A, AF, H, HF		
Anchor size		10			12			14		
Nominal embedment depth	h_{nom} [mm]	55	75	85	60	80	100	65	85	115
Drill hole depth	h_{1min} [mm]	$h_{nom} + 10$ mm								
Tension	N_{rec} [kN]	6,8	10,5	11,3	8,0	11,4	14,3	8,7	12,6	17,9
Shear	V_{rec} [kN]	7,2	12,0	12,6	11,1	13,5	15,9	12,1	15,0	17,6

Design resistance: Concrete C45/55

Type	HUS4	A, AF, C, H, HF			H			A, AF, H, HF		
Anchor size		10			12			14		
Nominal embedment depth	h_{nom} [mm]	55	75	85	60	80	100	65	85	115
Drill hole depth	h_{1min} [mm]	$h_{nom} + 10$ mm								
Tension	N_{Rd} [kN]	11,7	18,1	19,3	13,8	19,6	24,6	14,9	21,7	30,7
Shear	V_{Rd} [kN]	12,3	16,7	17,6	15,5	18,8	22,2	17,3	20,9	24,7

Recommended load: Concrete C45/55

Type	HUS4	A, AF, C, H, HF			H			A, AF, H, HF		
Anchor size		10			12			14		
Nominal embedment depth	h_{nom} [mm]	55	75	85	60	80	100	65	85	115
Drill hole depth	h_{1min} [mm]	$h_{nom} + 10$ mm								
Tension	N_{rec} [kN]	8,4	12,9	13,8	9,8	14,0	17,6	10,6	15,5	21,9
Shear	V_{rec} [kN]	8,8	12,0	12,6	11,1	13,5	15,9	12,3	15,0	17,6

Anchor spacing and edge distance

Type	HUS4	A, AF, C, H, HF			H			A, AF, H, HF		
Anchor size		10			12			14		
Minimum spacing	s_{min} [mm]	40			50			60		
Minimum edge distance	c_{min} [mm]	40			50			60		
Characteristic distances										
Spacing	s_{cr} [mm]				3 h_{ef}					
Edge distance	c_{cr} [mm]				1,5 h_{ef}					



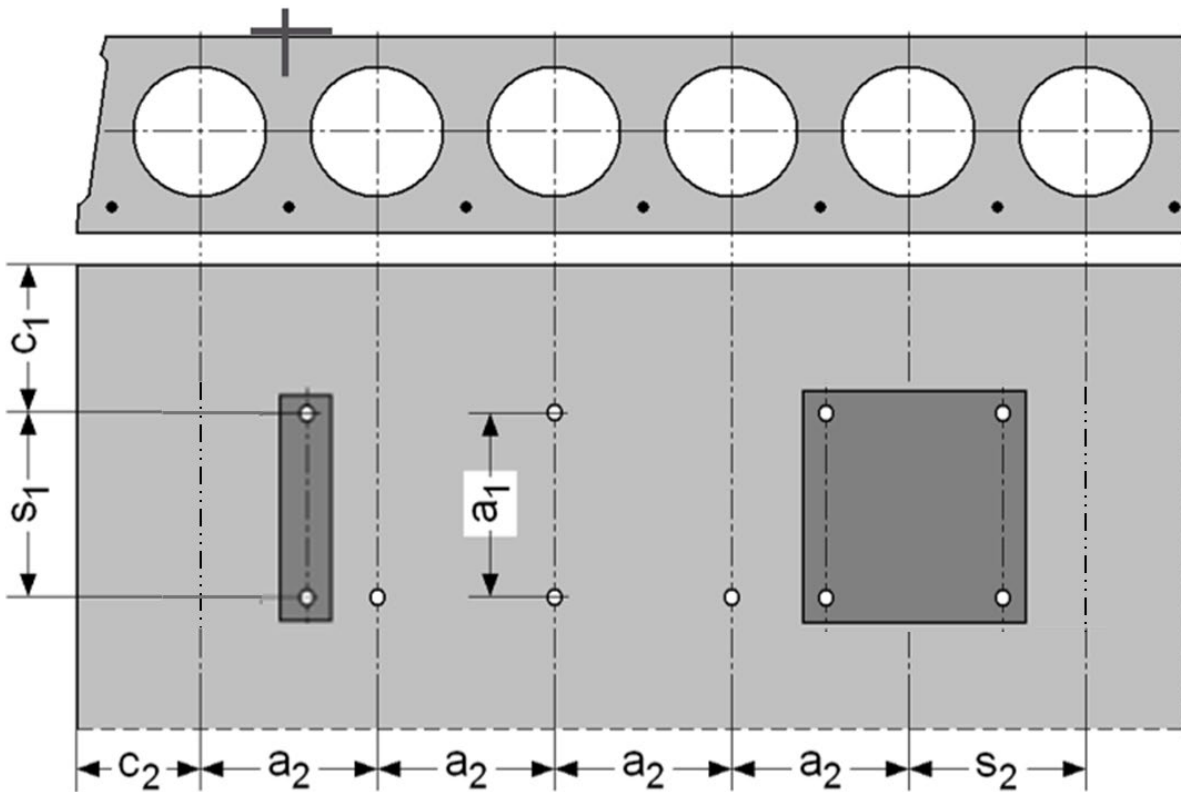

for single anchor





Drilling and Installation equipment

For detailed setting information on installation ,see instructions for use given with the product.

Rotary Hammers (Corded and Cordless)		TE 2 - TE 30
Other tools		Impact wrench- SIW (use recommended socket/driver bit)
		Hammer drill bit TE-CX , TE-C
		Blow out pump



HUS4 Screw anchor

Product Technical Datasheet

Metal decks

Steel-to-concrete

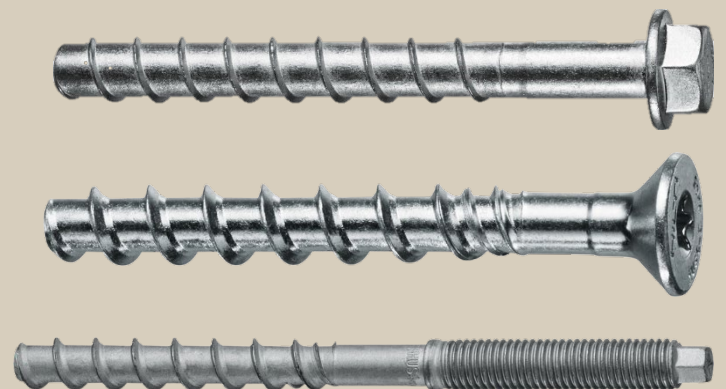

Update: Sep 24



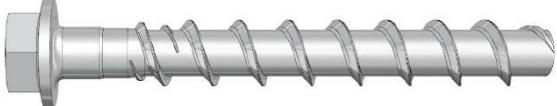

HUS4 Screw anchor for use with metal decks in concrete

High performance screw anchor for single point fastening into ComFlor® 60, 80 and SR

Anchor version	Benefits
 <p>HUS4-H(F) (8-10)</p>	<ul style="list-style-type: none"> - High productivity - less drilling and fewer operations than with conventional anchors
 <p>HUS4-C (8-10)</p>	<ul style="list-style-type: none"> - Two embedment depths for design flexibility and flexible design for concrete cone capacity
 <p>HUS4-A(F) (10)</p>	<ul style="list-style-type: none"> - No cleaning required for size 8 and 10 - HUS4-HF and HUS4-AF with multilayer coatings for additional corrosion protection - Through fastening with H, A and C head - Pre-fastening with A head



Base material Load conditions



Concrete (uncracked)



Concrete (cracked)



Static / quasi-static



Seismic, C1

Drilling, cleaning, setting Other information

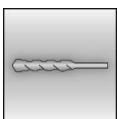

Hammer drilled holes



Hilti Technical data







Instructions for use

The instructions for use can be viewed using the link in the instructions for use table or the QR code/link in the Hilti webpage table.

Instructions for use (IFU)

Anchor size	8	10
H, HF	IFU HUS4-H(F)-8	IFU HUS4-H(F)-10
C	IFU HUS4-C-8	IFU HUS4-C-10
A, AF	-	IFU HUS4-A-10
Filling set	IFU Filling set	

Link to Hilti Webpage

HUS4-H	HUS4-HF	HUS4-C	HUS4-A	HUS4-AF	Filling set
					

Static and quasi-static loading based on Hilti technical data. Design according to EN 1992-4

All data in this section applies to:

- Correct setting (see setting instruction)
- Hammer drilled holes
- For a single anchor
- No edge distance and spacing influence (see setting detail tables with characteristic distances). Only one anchor can be used in the lower flute at a time with the min. spacing between anchors along the length of the flute to be at least $s = 3 h_{ef}$. This datasheet does not give information for the design of fasteners in a group.
- Minimum base material thickness (see setting detail table)
- Embedment depth, as specified in the table of this section
- Concrete from C30/37 without steel fiber for higher compressive strengths, the tension resistance may be increased by $(f'c / 30)^{0,5}$
- Recommended loads: With overall partial safety factor for action $\gamma = 1,4$.

For anchoring into the upper flute, either use table below conservatively or refer to ETA-20/0867. In this case the minimum required slab thickness h_{min} must be larger than the deck thickness $h_{min,deck}$.

Design resistance

Type	HUS4	H, HF, C		H, HF, C, A, AF	
Anchor size		8		10	
Nominal embedment depth h_{nom} [mm]		60	70	75	85
Uncracked concrete					
Tension N_{Rd} [kN]		10,6	11,7	12,8	13,3
Shear V_{Rd} [kN]		11,5	11,5	13,7	13,7
Cracked concrete					
Tension N_{Rd} [kN]		7,4	8,2	9,0	9,3
Shear V_{Rd} [kN]		11,5	11,5	13,7	13,7

Recommended loads

Type	HUS4	H, HF, C		H, HF, C, A, AF	
Anchor size		8		10	
Nominal embedment depth h_{nom} [mm]		60	70	75	85
Uncracked concrete					
Tension N_{rec} [kN]		7,6	8,3	9,1	9,5
Shear V_{rec} [kN]		8,2	8,2	9,8	9,8
Cracked concrete					
Tension N_{rec} [kN]		5,3	5,9	6,4	6,7
Shear V_{rec} [kN]		8,2	8,2	9,8	9,8

Seismic loading based on Hilti technical data. Design according to EN 1992-4

All data in this section applies to:

- Correct setting (see setting instruction)
- For a single anchor
- Hammer drilled holes
- No edge distance and spacing influence (see setting detail tables with characteristic distances). Only one anchor can be used in the lower flute at a time with the min.spacing between anchors along the length of the flute to be at least $s = 3 h_{ef}$. This datasheet does not give information for the design of fasteners in a group.
- Minimum base material thickness (see setting detail table)
- Embedment depth, as specified in the table of this section
- Concrete from C30/37 without steel fibre. For higher compressive strengths, the tension resistance may be increased by $(f'c / 30)^{0,5}$
- $\alpha_{gap} = 1,0$ (using Hilti filling set) and $\alpha_{gap} = 0,5$ (without using Hilti filling set) accordingly

For anchoring into the upper flute, either use table below conservatively or refer to ETA-20/0867. In this case the minimum required slab thickness h_{min} must be larger than the deck thickness $h_{min,deck}$.

Design resistance in case of seismic performance category C1

Type	HUS4	H, HF, C		H, HF, C, A, AF	
Anchor size		8		10	
Nominal embedment depth h_{nom} [mm]		60	70	75	85
with and without Hilti filling set					
Tension $N_{Rd,C}$ [kN]		7,4	8,2	9,0	9,3
with Hilti filling set ($\alpha_{gap} = 1,0$)					
Shear $V_{Rd,C}$ [kN]		11,8	11,8	13,8	13,8
without Hilti filling set ($\alpha_{gap} = 0,5$)					
Shear $V_{Rd,C}$ [kN]		5,8	5,8	6,9	6,9

Setting information

Setting details

Type	HUS4	H, HF, C		H, HF, C, A, AF	
Anchor size		8		10	
Nominal embedment depth	[mm]	60	70	75	85
Effective embedment depth	h_{ef} [mm]	47,6	56,1	59,5	68
Nominal diameter of drill bit	d_0 [mm]	8		10	
Clearance hole diameter	d_f [mm]	12		14	
Wrench size HUS4-H	SW1 [mm]	13		15	
Wrench size HUS4-A	SW1 [mm]	-		8	
Wrench size for nut on HUS4-A	SW2 [mm]	-		19	
Torx size for HUS4-C	TX [-]	45		50	
Countersunk head diameter	d_h [mm]	18		21	
Depth of drill hole for cleaned or uncleaned hole overhead	h_{1min} [mm]	70	80	85	95
Minimum base material thickness	h_{min} [mm]	125	125	130	140
Minimum concrete thickness over upper flute	$h_{min,deck}$ [mm]	70	70	70	70
Minimum distances					
Spacing	s_{min} [mm]	$3 h_{ef}$		$3,3 h_{ef}$	
Edge distance	c_{min} [mm]	$1,5 h_{ef}$		$1,65 h_{ef}$	
Minimum distance to edge of lower flute	$c_{min,deck}$ [mm]	45		47	
Characteristics distances					
Spacing for splitting failure	$s_{cr,sp}$ [mm]	$3 h_{ef}$		$3,3 h_{ef}$	
Edge distance for splitting	$c_{cr,sp}$ [mm]	$1,5 h_{ef}$		$1,65 h_{ef}$	
Spacing for concrete cone failure	$s_{cr,N}$ [mm]	$3 h_{ef}$			
Edge distance for concrete cone failure	$c_{cr,N}$ [mm]	$1,5 h_{ef}$			

For spacing (edge distance) smaller than characteristic spacing (characteristic edge distance) the design loads have to be reduced.

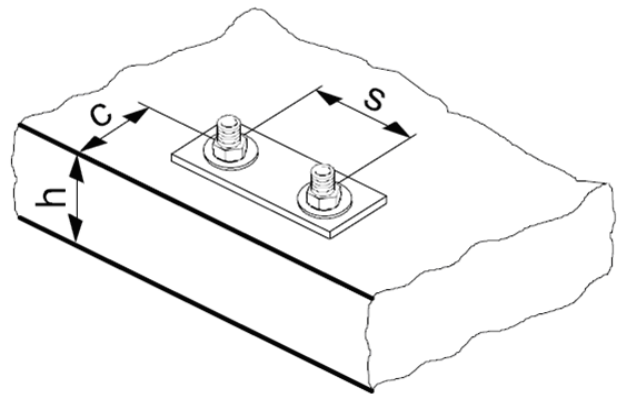

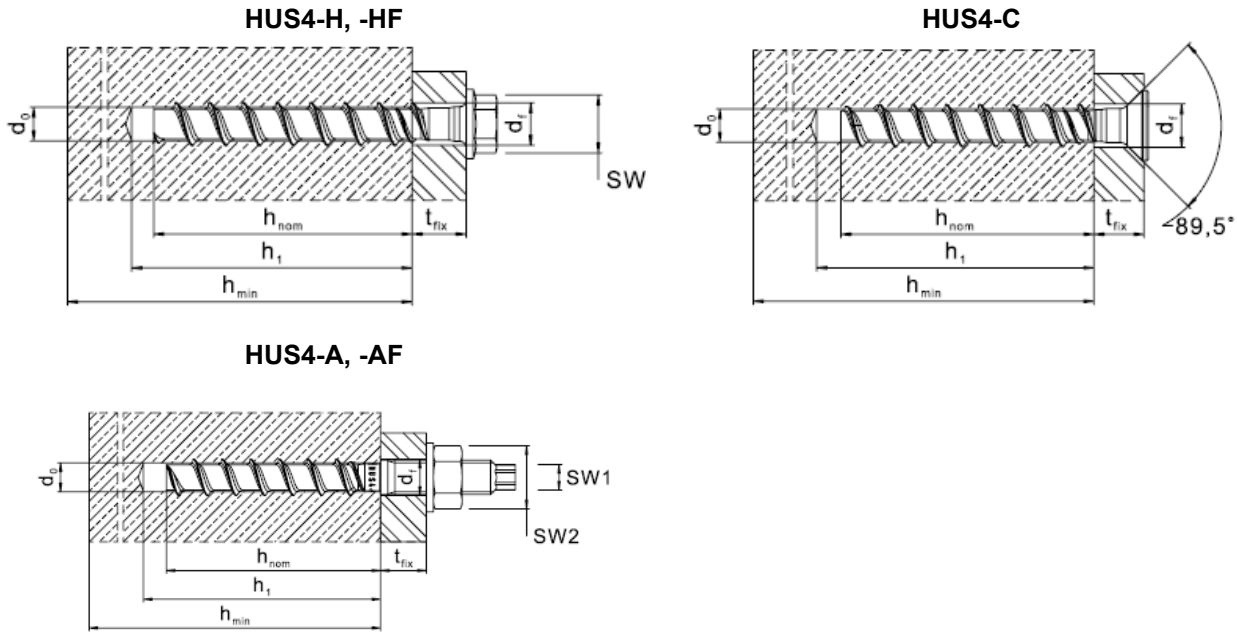



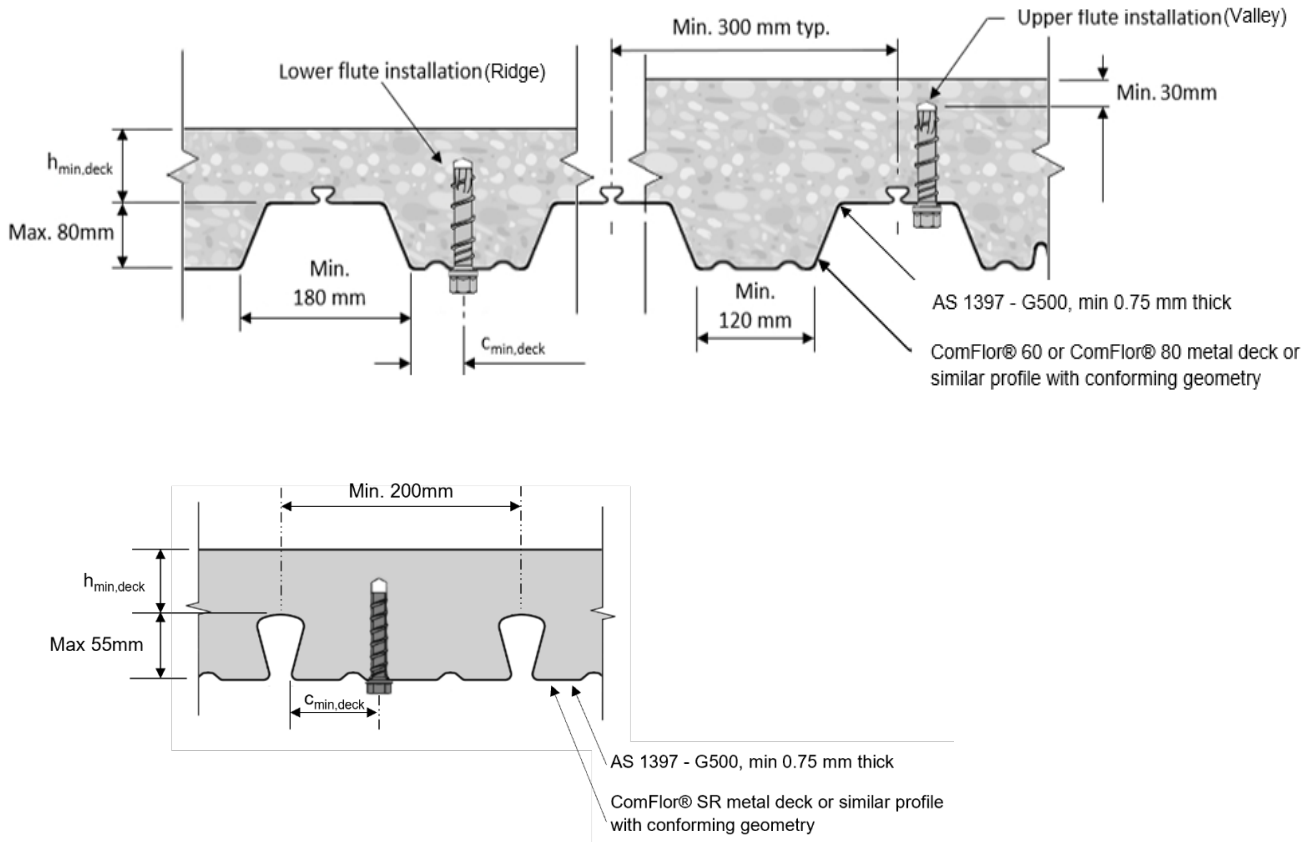

Installation position for HUS4 anchor in metal decks :





Drilling and Installation equipment

For detailed setting information on installation ,see instructions for use given with the product.

Rotary Hammers (Corded and Cordless)		TE 2 - TE 30
Other tools		Impact wrench- SIW (use recommended socket/driver bit)
		Hammer drill bit TE-CX, TE-C
		Blow out pump