



X-FCM-F L LARGE GRATING FASTENER DISC (DUPLEX COATED)

Data Sheet

[English](#)

[Deutsch](#)

[Español](#)

[Français](#)

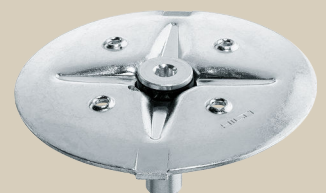

12.2023



X-FCM-F L LARGE GRATING FASTENER DISC (DUPLEX COATED)

Data Sheet

[English](#)

12.2023

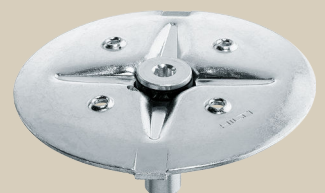

CONTENTS

1	Product info	2
1.1	Product description	2
2	Fastening system	3
3	Application conditions	3
3.1	Applications	3
3.2	Base materials	3
3.3	Load conditions	4
3.4	Environmental conditions	4
4	Approvals and certificates	4
5	Product data	5
5.1	Dimensions	5
5.2	Material properties for carbon steel parts	6
5.3	Material properties for plastic parts	6
6	Application requirements	6
6.1	Grating material properties	6
6.2	Fastener application ranges	7
6.3	Grating element recommendation	7
6.4	Grating element recommendation for use with Threaded Stud Extension X-SEA	7
7	Performance data	8
7.1	Recommended loads	8
7.2	Calculation method for design resistance	8
8	Installation recommendation	9
8.1	Tightening tool recommendation	9
9	Ordering information	10
9.1	Item no. and description	10

1 PRODUCT INFO

1.1 Product description

Designation	Features
<p data-bbox="363 555 459 577">X-FCM-F L</p> 	<ul data-bbox="627 555 1479 698" style="list-style-type: none">• Approvals and certificates – technical data, test reports and approvals available• Durable hold – locking tabs on the disc help to prevent loosening or spinning• Labor-saving grating installation – fewer steps than traditional grating clamps and welding.• No surface rework needed – when fastening grating to steel with S-BT and X-BT threaded studs• Reduce trip hazards – non-slip surface and minimized protrusion on walkway gratings when correctly installed

2 FASTENING SYSTEM

	S-BT-GF M8/7 AN 6 HL	S-BT-GR M8/7 SN 6 HL	S-BT-GR M8/7 SN 6 HL AL	S-BT-MF M8/15 AN 6 HL	X-BT-GR M8/7 SN 8	X-ST-GR M8/10 P8
Fastener						
Base materials	Steel	Steel	Aluminium	Steel	Steel	Steel
X-FCM-F L	■	■	■	■	■	■

- Recommended for combination
- Suitable for combination

• Possible to be used with Threaded Stud Extension X-SEA-R.

3 APPLICATION CONDITIONS

3.1 Applications

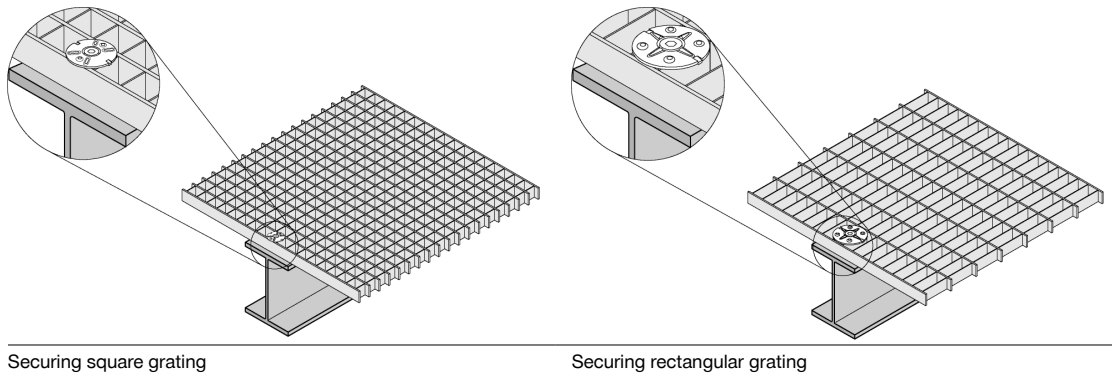

Securing square grating

Securing rectangular grating

3.2 Base materials

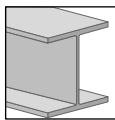

Steel

3.3 Load conditions



Static/quasi-static

3.4 Environmental conditions

X-FCM-F L combined with S-BT-GF M8/7 AN 6 HL, S-BT-MF M8/15 AN 6 HL, X-ST-GR M8/10 P8

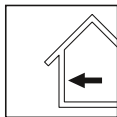

Dry indoor



Indoor environments with temporary condensation

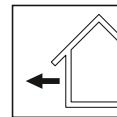



Outdoor, rural or urban environment with low pollution



Outdoor, rural or urban environment with moderate concentration of pollutants and/or salt from sea water



-  Suitable for corrosion prevention
-  Requires expert evaluation



- For more details, please refer to the [Hilti Corrosion Handbook](#)

4 APPROVALS AND CERTIFICATES

Authority	Approval/ certificate no	Date of issue
American Bureau of Shipping (ABS)	22-2285526-PDA	09/07/2022
Bureau Veritas (BV)	BV 71291/A0 BV	06/07/2023
Det Norske Veritas (DNV)	TAS00001UJ Rev. 4	08/22/2023



- Information presented in this product data sheet is based on Hilti Technical Data.
- For the specific application please refer to the corresponding approval/certificate.

5 PRODUCT DATA

5.1 Dimensions

X-FCM-F L

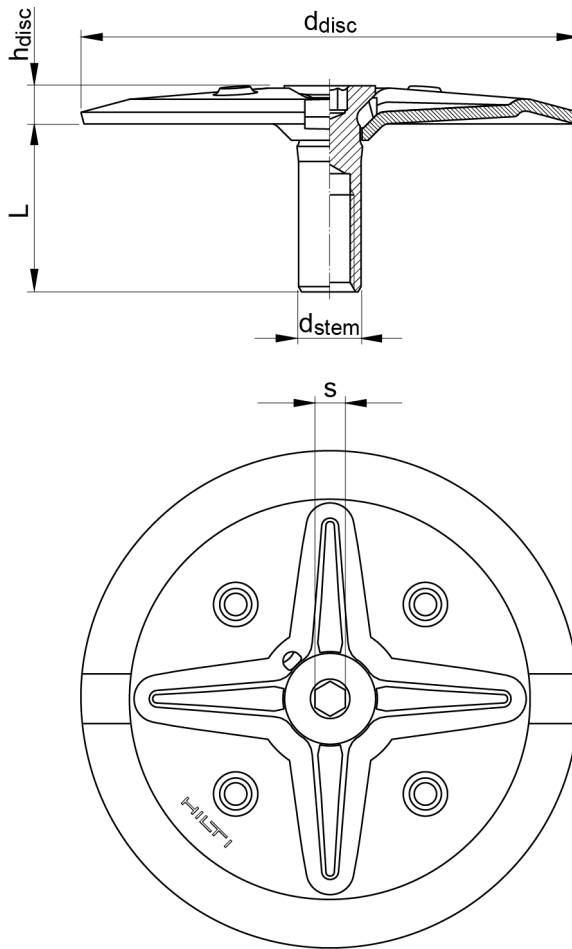

Designation	Length	Stem diameter	Disc diameter	Disc height	Hex width
	L [mm]	d _{stem} [mm]	d _{disc} [mm]	h _{disc} [mm]	s [mm]
X-FCM-F L 28/33	23	10.3	82	4	5
X-FCM-F L 32/37	27	10.3	82	4	5
X-FCM-F L 38/43	33	10.3	82	4	5
X-FCM-F L 48/53	43	10.3	82	4	5

5.2 Material properties for carbon steel parts

Designation	Element	Material	Coating	Coating thickness	Corrosivity category
				t_c [μm]	
X-FCM-F L	Disc, threaded stem	Carbon steel	Duplex coated		C3



- Category of corrosivity of the atmosphere according to EN ISO 9223.
- Coating thickness t_c : Duplex coating system equivalent to 45 μm of zinc coating (480 h salt spray test according to DIN EN ISO 9227).

5.3 Material properties for plastic parts

Designation	Element	Material	Color
X-FCM-F L	Absorber O-Ring	Polyurethane (PUR)	Black

6 APPLICATION REQUIREMENTS

6.1 Grating material properties

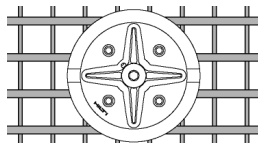

Grating type	Square
Clear bar spacing $w_{\text{bearing bar}}$ [mm]	30–60
Clear cross bar spacing $w_{\text{cross bar}}$ [mm]	30–60
Grating height h_G [mm]	28–53
Grating height h_G with X-SEA [mm]	58–83

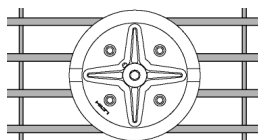

Grating type	Rectangular
Clear bar spacing $w_{\text{bearing bar}}$ [mm]	30–57
Grating height h_G [mm]	28–53
Grating height h_G with X-SEA [mm]	58–83

6.2 Fastener application ranges

- Application areas are provided in the corresponding Product Data Sheet(s) for fasteners.

6.3 Grating element recommendation

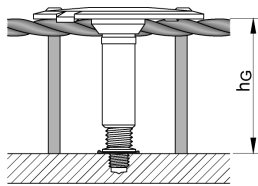

Designation	Grating material	Grating type	Grating height h_G [mm]
X-FCM-F L 28/33	Carbon steel,	Rectangular, Square	28-33
X-FCM-F L 32/37	Reinforced fiberglass		32-37
X-FCM-F L 38/43			38-43
X-FCM-F L 48/53			48-53

6.4 Grating element recommendation for use with Threaded Stud Extension X-SEA

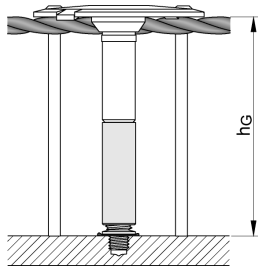

Designation	Grating material	Grating type	Grating height h_G [mm]
X-FCM-F L 28/33	Carbon steel,	Rectangular, Square	58-63
X-FCM-F L 32/37	Reinforced fiberglass		62-67
X-FCM-F L 38/43			68-73
X-FCM-F L 48/53			78-83

7 PERFORMANCE DATA

7.1 Recommended loads

Designation	Grating type	Clear bar spacing	Tension load
		$w_{\text{bearing bar}}$ [mm]	N_{rec} [kN]
X-FCM-F L combined with S-BT-GF M8/7 AN 6 HL, S-BT-MF M8/15 AN 6 HL	Square	30	1.8
		60	0.8
	Rectangular	30	0.8
		57	0.8

Designation	Grating type	Clear bar spacing	Tension load
		$w_{\text{bearing bar}}$ [mm]	N_{rec} [kN]
X-FCM-F L combined with X-ST-GR M8/10 P8	Square	30	1.8
		60	0.8
	Rectangular	30	0.8
		57	0.8



- Not suitable for explicit shear load design, e.g. diaphragms.
- Shear resistance by friction is depending on surface characteristics.
- Small unexpected shear loads can be accommodated without damage.
- Shear loads up to 0.3 kN will not result in permanent deformation.

7.2 Calculation method for design resistance

Load type	Equation	Partial safety factor for actions γ_f
Tension Load	$N_{\text{Rd}} = N_{\text{rec}} \cdot \gamma_f$	1.4
Shear Load	$V_{\text{Rd}} = V_{\text{rec}} \cdot \gamma_f$	1.4

8 INSTALLATION RECOMMENDATION

8.1 Tightening tool recommendation

Designation	Base materials	Base material thickness	Tightening torque	Tool type	Clutch type (stop detection)	Tool power level
		t_{II} [mm]	T_{rec} [Nm]			Gear / Clutch
X-FCM-F L combined with S-BT-GF M8/7 AN 6 HL, S-BT-MF M8/15 AN 6 HL	Steel	≥ 3	8	Calibrated torque wrench		
				X-BT 1/4" - 8 Nm		
				SBT 4-A22	TRC	1 / 7
				SBT 6-22	ESC (SJ)	1 / 7
				SF 18-A	TRC	1 / 5
				SF 2-A12	TRC	1 / 15
				SF 22-A	TRC	1 / 5
				SF 2H-A12	TRC	1 / 15
				SF 4-A22	TRC	1 / 8
				SF 6-A22	ESC (SJ)	1 / 7
				SF 6H-A22	ESC (SJ)	1 / 7
				SFC 18-A	TRC	1 / 5
				SFC 22-A	TRC	1 / 5

Designation	Base materials	Base material thickness	Tightening torque	Tool type	Clutch type (stop detection)	Tool power level
		t_{II} [mm]	T_{rec} [Nm]			Gear / Clutch
X-FCM-F L combined with X-ST-GR M8/10 P8	Steel	≥ 6	8	Calibrated torque wrench		
				X-BT 1/4" - 8 Nm		
				SBT 4-A22	TRC	1 / 7
				SBT 6-22	ESC (SJ)	1 / 7
				SF 18-A	TRC	1 / 5
				SF 2-A12	TRC	1 / 15
				SF 22-A	TRC	1 / 5
				SF 2H-A12	TRC	1 / 15
				SF 4-A22	TRC	1 / 8
				SF 6-A22	ESC (SJ)	1 / 7
				SF 6H-A22	ESC (SJ)	1 / 7
				SFC 18-A	TRC	1 / 5
				SFC 22-A	TRC	1 / 5



- Electronic slip clutch (ESC): ESC has 2 stop detections, Soft Joint (SJ) and Hard Joint (HJ) . Hard joint detection is activated due to drop in speed (fast stop) and can lead to a torque spike.
- Torque release coupling (TRC): Achievable torque can change over time due to clutch wear.

9 ORDERING INFORMATION

9.1 Item no. and description

Designation	Item number	Description
X-FCM-F L 28/33	2354532	X-FCM-F L Large grating fastener disc (duplex coated)
X-FCM-F L 32/37	2354533	
X-FCM-F L 38/43	2354534	
X-FCM-F L 48/53	2354535	
S-BT-GF M8/7 AN 6 HL	2345766	S-BT-GF HL Threaded stud
S-BT-MF M8/15 AN 6 HL	2345769	S-BT-MF HL Threaded stud
X-ST-GR M8/10 P8	2122460	X-ST-GR M8



Hilti Aktiengesellschaft
9494 Schaan, Liechtenstein
P +423-234 2965

www.facebook.com/hiltigroup
www.hilti.group



X-FCM-F L GITTERROST- BEFESTIGUNGS- TELLER, GROß (DUPLEX- BESCHICHTET)

Datenblatt

[Deutsch](#)

12.2023

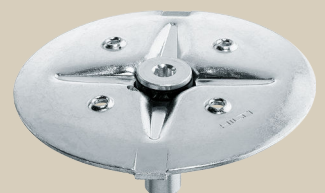

INHALTSVERZEICHNIS

1	Produktinformation	2
1.1	Produktbeschreibung	2
2	Befestigungssystem	3
3	Anwendungsbedingungen	3
3.1	Anwendungen	3
3.2	Untergrundmaterial	3
3.3	Lastbedingungen	4
3.4	Umgebungsbedingungen	4
4	Zulassungen und Zertifikate	4
5	Produktdaten	5
5.1	Abmessungen	5
5.2	Materialeigenschaften für Teile aus Kohlenstoffstahl	6
5.3	Materialeigenschaften für Kunststoffteile	6
6	Anwendungsbedingungen	6
6.1	Materialeigenschaften von Gitterrosten	6
6.2	Anwendungsbereiche der Befestigungselemente	7
6.3	Empfehlung für Gitterrostbefestiger	7
6.4	Empfehlung für Gitterrostbefestiger zur Verwendung mit Gewindebolzen-Verlängerung X-SEA	7
7	Leistungsdaten	8
7.1	Empfohlene Lasten	8
7.2	Berechnungsmethode für Bemessungswiderstand	8
8	Montageempfehlung	9
8.1	Empfehlung für Anziehwerkzeuge	9
9	Bestellinformation	10
9.1	Artikel-Nr. und Beschreibung	10

1 PRODUKTINFORMATION

1.1 Produktbeschreibung

Bezeichnung	Besondere Eigenschaften
X-FCM-F L	<ul style="list-style-type: none">• Keine Nachbearbeitung notwendig – bei Befestigung von Gitterrosten an Stahl mit S-BT und X-BT Gewindebolzen• Minimaler Installationsaufwand – weniger Schritte als mit herkömmlichen Gitterrostklappen und Schweißen.• Sicherer Halt – Sicherungslaschen am Teller helfen, ein Lösen oder Mitdrehen zu verhindern• Weniger Stolperfallen – rutschfreie Oberfläche und bei richtiger Montage minimaler Überstand über Laufroste• Zulassungen und Zertifikate – technische Daten, Prüfberichte und Zulassungen verfügbar



2 BEFESTIGUNGSSYSTEM

Befestigungselement	S-BT-GF M8/7 AN 6 HL	S-BT-GR M8/7 SN 6 HL	S-BT-GR M8/7 SN 6 HL AL	S-BT-MF M8/15 AN 6 HL	X-BT-GR M8/7 SN 8	X-ST-GR M8/10 P8
Untergrundmaterial	Stahl	Stahl	Aluminium	Stahl	Stahl	Stahl
X-FCM-F L	■	■	■	■	■	■

- Empfohlen für Kombination
- Geeignet für Kombination

• Kann mit Gewindebolzen-Verlängerung X-SEA-R verwendet werden.

3 ANWENDUNGSBEDINGUNGEN

3.1 Anwendungen

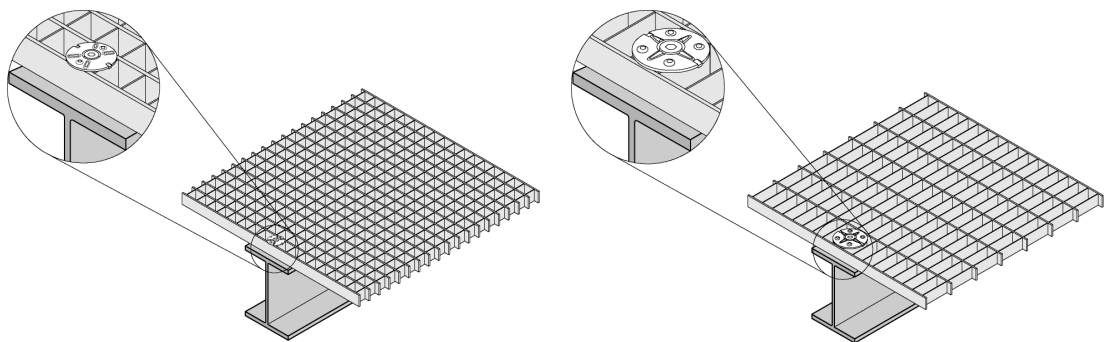

Sicherung quadratischer Gitterroste

Sicherung rechteckiger Gitterroste

3.2 Untergrundmaterial

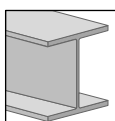

Stahl

3.3 Lastbedingungen



Statisch/quasi-statisch

3.4 Umgebungsbedingungen

X-FCM-F L in Verbindung mit S-BT-GF M8/7 AN 6 HL, S-BT-MF M8/15 AN 6 HL, X-ST-GR M8/10 P8



Trockene Innenräume



Innenbereiche mit temporärer
Kondensation

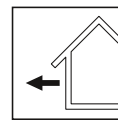

Außenbereich, ländliche oder
städtische Umgebung mit
geringer
Umweltverschmutzung

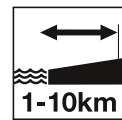

Im Freien, in ländlicher oder
städtischer Umgebung mit
mäßiger
Schadstoffkonzentration
und/oder Salzen aus dem
Meerwasser



- Geeignet für den Korrosionsschutz
- Erfordert Expertenbewertung



- Weitere Einzelheiten entnehmen Sie bitte dem [Hilti Corrosion Handbook](#)

4 ZULASSUNGEN UND ZERTIFIKATE

Behörde	Zulassungs-/Zertifikatsnummer	Ausgabedatum
American Bureau of Shipping (ABS)	22-2285526-PDA	07.09.2022
Bureau Veritas (BV)	BV 71291/A0 BV	07.06.2023
Det Norske Veritas (DNV)	TAS00001UJ Rev. 4	22.08.2023



- Die in diesem Produktdatenblatt enthaltenen Informationen basieren auf den technischen Daten von Hilti.
- Für die spezifische Anwendung wird auf die entsprechende Zulassung/Bescheinigung verwiesen.

5 PRODUKTDATEN

5.1 Abmessungen

X-FCM-F L

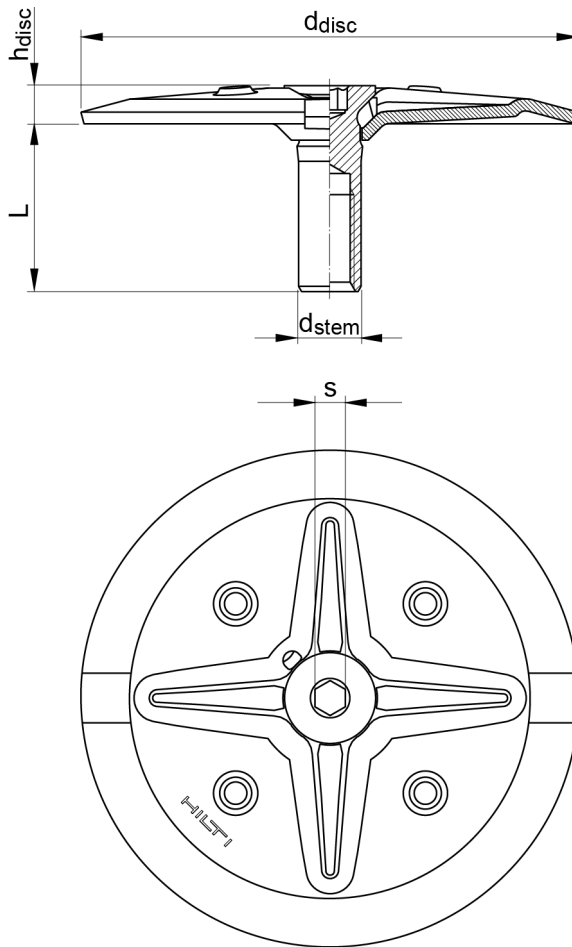

Bezeichnung	Länge	Buchsendurchmesser	Tellerdurchmesser	Tellerhöhe	Inbus Größe
	L [mm]	d _{stem} [mm]	d _{disc} [mm]	h _{disc} [mm]	s [mm]
X-FCM-F L 28/33	23	10,3	82	4	5
X-FCM-F L 32/37	27	10,3	82	4	5
X-FCM-F L 38/43	33	10,3	82	4	5
X-FCM-F L 48/53	43	10,3	82	4	5

5.2 Materialeigenschaften für Teile aus Kohlenstoffstahl

Bezeichnung	Element	Material	Beschichtung	Beschichtungs- dicke t_c [μm]	Korrosionskatego- rie
X-FCM-F L	Scheibe, Gewindeschaft	Kohlenstoffstahl	Duplex beschichtet		C3



- Kategorie der umgebungsbedingten Korrosivität nach EN ISO 9223.
- Schichtdicke t_c : Duplex-Beschichtungssystem entspricht einer Zinkschicht von 45 μm (480 h Salzsprühtest nach DIN EN ISO 9227).

5.3 Materialeigenschaften für Kunststoffteile

Bezeichnung	Element	Material	Farbe
X-FCM-F L	Dämpfer O-Ring	Polyurethan (PUR)	Schwarz

6 ANWENDUNGSBEDINGUNGEN

6.1 Materialeigenschaften von Gitterrosten

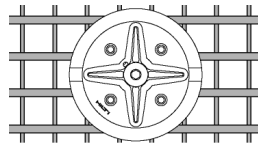

Gitterrostart	Quadratisch
Lichter Stababstand $w_{\text{bearing bar}}$ [mm]	30 – 60
Lichter Stababstand Querstäbe $w_{\text{cross bar}}$ [mm]	30 – 60
Gitterrosthöhe h_G [mm]	28 – 53
Gitterrosthöhe h_G mit X-SEA [mm]	58 – 83

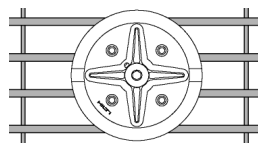

Gitterrostart	Rechteckig
Lichter Stababstand $w_{\text{bearing bar}}$ [mm]	30 – 57
Gitterrosthöhe h_G [mm]	28 – 53
Gitterrosthöhe h_G mit X-SEA [mm]	58 – 83

6.2 Anwendungsbereiche der Befestigungselemente

- i** • Die Anwendungsbereiche sind in den entsprechenden Produktdatenblättern für Befestigungselemente angegeben.

6.3 Empfehlung für Gitterrostbefestiger

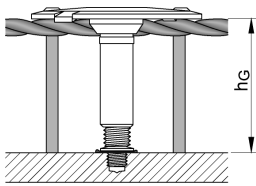

Bezeichnung	Gitterrostmaterial	Gitterrostart	Gitterrosthöhe h_G [mm]
X-FCM-F L 28/33	Glasfaserverstärkt,	Quadratisch,	28-33
X-FCM-F L 32/37	Kohlenstoffstahl	Rechteckig	32-37
X-FCM-F L 38/43			38-43
X-FCM-F L 48/53			48-53

6.4 Empfehlung für Gitterrostbefestiger zur Verwendung mit Gewindebolzen-Verlängerung X-SEA

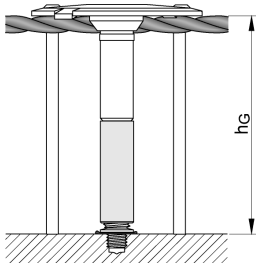

Bezeichnung	Gitterrostmaterial	Gitterrostart	Gitterrosthöhe h_G [mm]
X-FCM-F L 28/33	Glasfaserverstärkt,	Quadratisch,	58-63
X-FCM-F L 32/37	Kohlenstoffstahl	Rechteckig	62-67
X-FCM-F L 38/43			68-73
X-FCM-F L 48/53			78-83

7 LEISTUNGSDATEN

7.1 Empfohlene Lasten

Bezeichnung	Gitterrost	Lichter Stababstand	Zuglast
		$w_{\text{bearing bar}}$ [mm]	N_{rec} [kN]
X-FCM-F L in Verbindung mit S-BT-GF M8/7 AN 6 HL, S-BT-MF M8/15 AN 6 HL	Rechteckig	30	0,8
		57	0,8
	Quadratisch	30	1,8
		60	0,8

Bezeichnung	Gitterrost	Lichter Stababstand	Zuglast
		$w_{\text{bearing bar}}$ [mm]	N_{rec} [kN]
X-FCM-F L in Verbindung mit X-ST-GR M8/10 P8	Rechteckig	30	0,8
		57	0,8
	Quadratisch	30	1,8
		60	0,8



- Nicht geeignet für Konstruktionen mit klaren Querkraftwirkungen, z. B. Membranen.
- Die Querkrafttragfähigkeit hängt von den Oberflächeneigenschaften ab.
- Kleine unerwartete Scherkräfte können ohne Schaden aufgenommen werden.
- Querkräfte bis zu 0,3 kN führen nicht zu bleibenden Verformungen.

7.2 Berechnungsmethode für Bemessungswiderstand

Belastungsart	Gleichung	Teilsicherheitsfaktor für Einwirkungen γ_f
Zuglast	$N_{\text{Rd}} = N_{\text{rec}} \cdot \gamma_f$	1,4
Querlast	$V_{\text{Rd}} = V_{\text{rec}} \cdot \gamma_f$	1,4

8 MONTAGEEMPFEHLUNG

8.1 Empfehlung für Anziehwerkzeuge

Bezeichnung	Untergrundmaterial	Dicke des Untergrundmaterials	Anzugsdrehmoment	Gerätetyp	Kupplungsart (Stopp-Erkennung)	Werkzeugleistungsstufe
		t_{II} [mm]	T_{rec} [Nm]			
X-FCM-F L in Verbindung mit S-BT-GF M8/7 AN 6 HL, S-BT-MF M8/15 AN 6 HL	Stahl	≥ 3	8	Calibrated torque wrench		
				X-BT 1/4" – 8 Nm		
				SBT 4-A22	TRC	1 / 7
				SBT 6-22	ESC (SJ)	1 / 7
				SF 18-A	TRC	1 / 5
				SF 2-A12	TRC	1 / 15
				SF 22-A	TRC	1 / 5
				SF 2H-A12	TRC	1 / 15
				SF 4-A22	TRC	1 / 8
				SF 6-A22	ESC (SJ)	1 / 7
				SF 6H-A22	ESC (SJ)	1 / 7
				SFC 18-A	TRC	1 / 5
				SFC 22-A	TRC	1 / 5

Bezeichnung	Untergrundmaterial	Dicke des Untergrundmaterials	Anzugsdrehmoment	Gerätetyp	Kupplungsart (Stopp-Erkennung)	Werkzeugleistungsstufe
		t_{II} [mm]	T_{rec} [Nm]			
X-FCM-F L in Verbindung mit X-ST-GR M8/10 P8	Stahl	≥ 6	8	Calibrated torque wrench		
				X-BT 1/4" – 8 Nm		
				SBT 4-A22	TRC	1 / 7
				SBT 6-22	ESC (SJ)	1 / 7
				SF 18-A	TRC	1 / 5
				SF 2-A12	TRC	1 / 15
				SF 22-A	TRC	1 / 5
				SF 2H-A12	TRC	1 / 15
				SF 4-A22	TRC	1 / 8
				SF 6-A22	ESC (SJ)	1 / 7
				SF 6H-A22	ESC (SJ)	1 / 7
				SFC 18-A	TRC	1 / 5
				SFC 22-A	TRC	1 / 5



- Elektronische Rutschkupplung (ESC): Die ESC verfügt über 2 Stopp-Erkennungen, weicher Schraubabfall (SJ) und harter Schraubabfall (HJ). Die Erkennung des harten Schraubabfalls wird durch einen Geschwindigkeitsabfall (Schnellstopp) aktiviert und kann zu einer Drehmomentspitze führen.
- Drehmomentbegrenzer (TRC): Das erreichbare Drehmoment kann sich im Laufe der Zeit aufgrund von Kupplungsverschleiß ändern.

9 BESTELLINFORMATION

9.1 Artikel-Nr. und Beschreibung

Bezeichnung	Artikelnummer	Beschreibung
X-FCM-F L 28/33	2354532	X-FCM-F L Gitterrost-Befestigungsteller, groß (Duplex-beschichtet)
X-FCM-F L 32/37	2354533	
X-FCM-F L 38/43	2354534	
X-FCM-F L 48/53	2354535	
S-BT-GF M8/7 AN 6 HL	2345766	S-BT-GF HL Gewindebolzen
S-BT-MF M8/15 AN 6 HL	2345769	S-BT-MF HL Gewindebolzen
X-ST-GR M8/10 P8	2122460	X-ST-GR M8



Hilti Aktiengesellschaft
9494 Schaan, Liechtenstein
P +423-234 2965

www.facebook.com/hiltigroup
www.hilti.group



X-FCM-F L DISCO DE FIJACIÓN DE REJILLA INDUSTRIAL GRANDE (DOBLE REVESTIMIENTO)

Hoja de datos

[Español](#)

12.2023

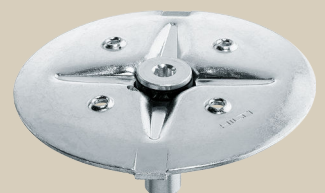

ÍNDICE

1	Información del producto	2
1.1	Descripción del producto	2
2	Sistema de fijación	3
3	Condiciones de aplicación	3
3.1	Aplicaciones	3
3.2	Materiales base	3
3.3	Condiciones de carga	4
3.4	Condiciones ambientales	4
4	Homologaciones y certificados	4
5	Datos del producto	5
5.1	Dimensiones	5
5.2	Propiedades del material para piezas de acero al carbono	6
5.3	Propiedades del material para piezas de plástico	6
6	Requisitos de aplicación	6
6.1	Propiedades de material de rejilla industrial	6
6.2	Rangos de aplicación de la fijación	7
6.3	Recomendación de elemento de rejilla industrial	7
6.4	Recomendación de elemento de rejilla industrial con extensión de pernos roscados X-SEA	7
7	Datos de rendimiento	8
7.1	Cargas recomendadas	8
7.2	Procedimiento de cálculo de la resistencia de diseño	8
8	Recomendación de instalación	9
8.1	Recomendación de herramientas de ajuste	9
9	Información del pedido	10
9.1	Nº. y descripción del artículo	10

1. INFORMACIÓN DEL PRODUCTO

1.1. Descripción del producto

Designación	Características
X-FCM-F L 	<ul style="list-style-type: none">• Ahorro de tiempo en la instalación de rejillas industriales: proceso que requiere menos pasos que los sistemas tradicionales de grapas y soldadura.• Homologaciones y certificados: disponibilidad de datos técnicos, informes de ensayo y homologaciones• No requiere rectificación de la superficie cuando la rejilla industrial se fija a acero con los pernos roscados X-BT y S-BT• Reducción del riesgo de tropiezos: superficie antideslizante con protrusión mínima en rejillas industriales de pasarelas cuando la instalación se realiza correctamente• Sujeción duradera: las pestañas de bloqueo de la espiga evitan el giro o el desprendimiento

2. SISTEMA DE FIJACIÓN

	S-BT-GF M8/7 AN 6 HL	S-BT-GR M8/7 SN 6 HL	S-BT-GR M8/7 SN 6 HL AL	S-BT-MF M8/15 AN 6 HL	X-BT-GR M8/7 SN 8	X-ST-GR M8/10 P8
Fijación						
Materiales base	Acero	Acero	Aluminio	Acero	Acero	Acero
X-FCM-F L	■	■	■	■	■	■

- Recomendado para la combinación
- Adecuado para la combinación

 • Posibilidad de uso con la extensión de perno roscado X-SEA-R.

3. CONDICIONES DE APLICACIÓN

3.1. Aplicaciones

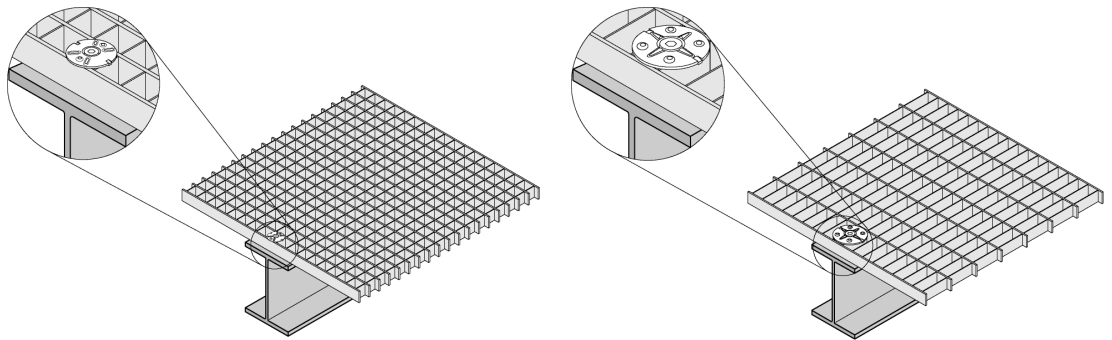

Fijación de rejilla industrial cuadrada

Fijación de rejilla industrial rectangular

3.2. Materiales base

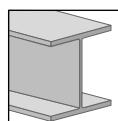

Acero

3.3. Condiciones de carga

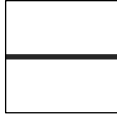

Estática y cuasi estática

3.4. Condiciones ambientales

X-FCM-F L combinado con S-BT-GF M8/7 AN 6 HL, S-BT-MF M8/15 AN 6 HL, X-ST-GR M8/10 P8

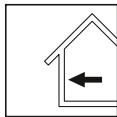

Interiores secos



Entornos interiores con condensación temporal

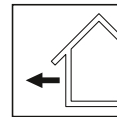

Entornos exteriores, rurales o urbanos con poca contaminación

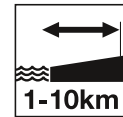

Entorno exterior, rural o urbano con una concentración moderada de contaminantes y/o sal del agua marina



■ Adecuado para la prevención de corrosión



■ Requiere la evaluación de un especialista



• Para obtener más información, consulte [Manual sobre corrosión de Hilti](#)

4. HOMOLOGACIONES Y CERTIFICADOS

Autoridad	N.º de homologación/certificado	Fecha de emisión
American Bureau of Shipping (ABS)	22-2285526-PDA	09/07/2022
Bureau Veritas (BV)	BV 71291/A0 EV	06/07/2023
Det Norske Veritas (DNV)	TAS00001UJ Rev. 4	08/22/2023



• La información que se presenta en esta hoja de datos del producto se basa en los datos técnicos de Hilti.
• Para obtener información sobre aplicaciones específicas, consulte el certificado o la homologación correspondientes.

5. DATOS DEL PRODUCTO

5.1. Dimensiones

X-FCM-F L

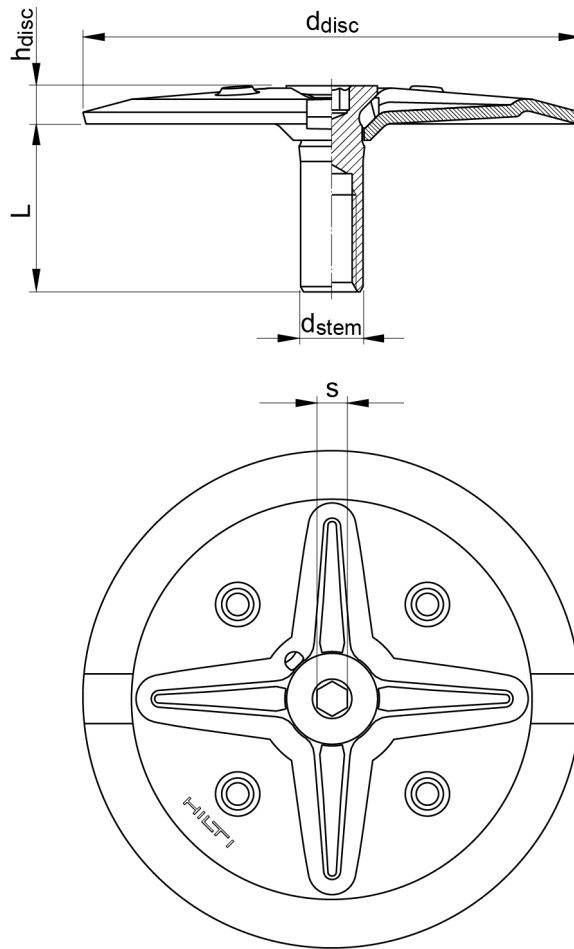

Designación	Longitud	Diámetro del vástago	Diámetro del disco	Altura del disco	Anchura hexagonal
	L [mm]	d _{stem} [mm]	d _{disc} [mm]	h _{disc} [mm]	s [mm]
X-FCM-F L 28/33	23	10,3	82	4	5
X-FCM-F L 32/37	27	10,3	82	4	5
X-FCM-F L 38/43	33	10,3	82	4	5
X-FCM-F L 48/53	43	10,3	82	4	5

5.2. Propiedades del material para piezas de acero al carbono

Designación	Elemento	Material	Revestimiento	Espesor del revestimiento t_c [μm]	Categoría de corrosión
X-FCM-F L	Disco, vástago roscado	Acero al carbono	Doble revestimiento		C3



- Categoría de corrosión de la atmósfera de conformidad con la norma EN ISO 9223.
- Espesor del recubrimiento t_c : Sistema de recubrimiento dúplex equivalente a 45 μm de recubrimiento de zinc (prueba de niebla salina de 480 h según DIN EN ISO 9227).

5.3. Propiedades del material para piezas de plástico

Designación	Elemento	Material	Color
X-FCM-F L	Junta tórica de absorción	Poliuretano (PUR)	Negro

6. REQUISITOS DE APLICACIÓN

6.1. Propiedades de material de rejilla industrial

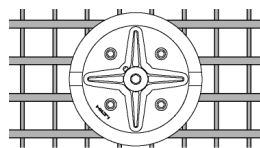

Tipo de rejilla industrial	Cuadrado
Separación entre barras $w_{\text{bearing bar}}$ [mm]	30-60
Separación entre barras transversales $w_{\text{cross bar}}$ [mm]	30-60
Altura de rejilla industrial h_G [mm]	28-53
Altura de rejilla industrial h_G con X-SEA [mm]	58-83

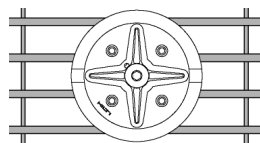

Tipo de rejilla industrial	Rectangular
Separación entre barras $w_{\text{bearing bar}}$ [mm]	30-57
Altura de rejilla industrial h_G [mm]	28-53
Altura de rejilla industrial h_G con X-SEA [mm]	58-83

6.2. Rangos de aplicación de la fijación

- Las áreas de aplicación se proporcionan en las hojas de datos de producto correspondientes para las fijaciones.

6.3. Recomendación de elemento de rejilla industrial

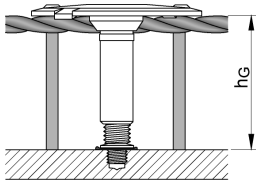

Designación	Material de rejilla industrial	Tipo de rejilla industrial	Altura de rejilla industrial h_G [mm]
X-FCM-F L 28/33	Acero al carbono, Fibra de vidrio reforzada	Cuadrado, Rectangular	28-33
X-FCM-F L 32/37			32-37
X-FCM-F L 38/43			38-43
X-FCM-F L 48/53			48-53

6.4. Recomendación de elemento de rejilla industrial con extensión de pernos roscados X-SEA

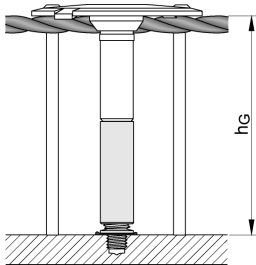

Designación	Material de rejilla industrial	Tipo de rejilla industrial	Altura de rejilla industrial h_G [mm]
X-FCM-F L 28/33	Acero al carbono, Fibra de vidrio reforzada	Cuadrado, Rectangular	58-63
X-FCM-F L 32/37			62-67
X-FCM-F L 38/43			68-73
X-FCM-F L 48/53			78-83

7. DATOS DE RENDIMIENTO

7.1. Cargas recomendadas

Designación	Tipo de rejilla industrial	Separación entre barras	Carga de tensión
		$w_{\text{bearing bar}}$ [mm]	N_{rec} [kN]
X-FCM-F L combinado con S-BT-GF M8/7 AN 6 HL, S-BT-MF M8/15 AN 6 HL	Rectangular	30	0,8
		57	0,8
	Cuadrado	30	1,8
		60	0,8

Designación	Tipo de rejilla industrial	Separación entre barras	Carga de tensión
		$w_{\text{bearing bar}}$ [mm]	N_{rec} [kN]
X-FCM-F L combinado con X-ST-GR M8/10 P8	Rectangular	30	0,8
		57	0,8
	Cuadrado	30	1,8
		60	0,8



- No apto para diseños carga cortante explícita, como, por ejemplo, diafragmas.
- La resistencia a cortante por fricción depende de las características de la superficie.
- Tolerancia sin daños a cargas cortantes leves e inesperadas.
- Las cargas cortantes de hasta 0,3 kN no provocarán deformación permanentemente.

7.2. Procedimiento de cálculo de la resistencia de diseño

Tipo de carga	Ecuación	Factor de seguridad parcial para acciones γ_f
Carga de tracción	$N_{\text{Rd}} = N_{\text{rec}} \cdot \gamma_f$	1,4
Carga cortante	$V_{\text{Rd}} = V_{\text{rec}} \cdot \gamma_f$	1,4

8. RECOMENDACIÓN DE INSTALACIÓN

8.1. Recomendación de herramientas de ajuste

Designación	Materiales base	Esesor del material base	Par de apriete	Tipo de herramienta	Tipo de embrague (detección de parada)	Nivel de potencia de la herramienta
		t_{II} [mm]	T_{rec} [Nm]			Marcha / Embrague
X-FCM-F L combinado con S-BT-GF M8/7 AN 6 HL, S-BT-MF M8/15 AN 6 HL	Acero	≥ 3	8	Llave dinamométrica calibrada		
				X-BT 1/4" - 8 Nm		
				SBT 4-A22	TRC	1 / 7
				SBT 6-22	ESC (SJ)	1 / 7
				SF 18-A	TRC	1 / 5
				SF 2-A12	TRC	1 / 15
				SF 22-A	TRC	1 / 5
				SF 2H-A12	TRC	1 / 15
				SF 4-A22	TRC	1 / 8
				SF 6-A22	ESC (SJ)	1 / 7
				SF 6H-A22	ESC (SJ)	1 / 7
				SFC 18-A	TRC	1 / 5
				SFC 22-A	TRC	1 / 5

Designación	Materiales base	Esesor del material base	Par de apriete	Tipo de herramienta	Tipo de embrague (detección de parada)	Nivel de potencia de la herramienta
		t_{II} [mm]	T_{rec} [Nm]			Marcha / Embrague
X-FCM-F L combinado con X-ST-GR M8/10 P8	Acero	≥ 6	8	Llave dinamométrica calibrada		
				X-BT 1/4" - 8 Nm		
				SBT 4-A22	TRC	1 / 7
				SBT 6-22	ESC (SJ)	1 / 7
				SF 18-A	TRC	1 / 5
				SF 2-A12	TRC	1 / 15
				SF 22-A	TRC	1 / 5
				SF 2H-A12	TRC	1 / 15
				SF 4-A22	TRC	1 / 8
				SF 6-A22	ESC (SJ)	1 / 7
				SF 6H-A22	ESC (SJ)	1 / 7
				SFC 18-A	TRC	1 / 5
				SFC 22-A	TRC	1 / 5



- Embrague de seguridad electrónico (ESC): el sistema ESC cuenta con 2 detecciones, juntas blandas (SJ) y juntas duras (HJ). La detección de junta dura se activa con la caída de la velocidad (parada rápida) y puede provocar un pico de par.
- Par de apriete de acoplamiento (TRC): el par de apriete obtenido puede cambiar con el tiempo debido al desgaste del embrague.

9. INFORMACIÓN DEL PEDIDO

9.1. N°. y descripción del artículo

Designación	Número de elemento	Descripción
X-FCM-F L 28/33	2354532	X-FCM-F L Disco de fijación de rejilla industrial grande (doble revestimiento)
X-FCM-F L 32/37	2354533	
X-FCM-F L 38/43	2354534	
X-FCM-F L 48/53	2354535	
S-BT-GF M8/7 AN 6 HL	2345766	S-BT-GF HL Perno roscado
S-BT-MF M8/15 AN 6 HL	2345769	S-BT-MF HL Perno roscado
X-ST-GR M8/10 P8	2122460	X-ST-GR M8



Hilti Aktiengesellschaft
9494 Schaan, Liechtenstein
P +423-234 2965

www.facebook.com/hiltigroup
www.hilti.group



X-FCM-F L GRANDE COUPELLE DE FIXATION POUR CAILLEBOTIS (REVÊTEMENT DUPLEX)

Fiche technique

[Français](#)

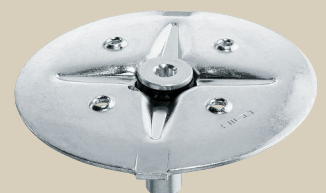

12.2023

TABLE DES MATIÈRES

1	Information produit	2
1.1	Description du produit	2
2	Système de fixation	3
3	Conditions d'application	3
3.1	Applications	3
3.2	Matériau support	3
3.3	Conditions de charge	4
3.4	Conditions environnementales	4
4	Homologations et certificats	4
5	Données produit	5
5.1	Dimensions	5
5.2	Propriétés du matériau pour pièces en acier au carbone	6
5.3	Propriétés du matériau pour pièces plastiques	6
6	Exigences en matière d'application	6
6.1	Propriétés du matériau de caillebotis	6
6.2	Plages d'applications de fixations	7
6.3	Élément de caillebotis recommandé	7
6.4	Élément de caillebotis recommandé avec l'extension de goujon fileté X-SEA	7
7	Données de performance	8
7.1	Charges recommandées	8
7.2	Méthode de calcul pour la résistance de conception	8
8	Recommandation sur l'installation	9
8.1	Recommandation sur l'outil de serrage	9
9	Information de commande	10
9.1	N° d'article et description	10

1 INFORMATION PRODUIT

1.1 Description du produit

Désignation	Caractéristiques
X-FCM-F L	<ul style="list-style-type: none">• Aucune retouche de surface nécessaire lors de la fixation de caillebotis sur l'acier avec des goujons filetés S-BT et X-BT• Économie de main d'œuvre sur la pose de caillebotis - moins d'étapes qu'avec les cavaliers traditionnels et la soudure• Homologations et certificats – données techniques, rapports d'essais et homologations disponibles• Réduction du risque de trébuchement – surface antidérapante et saillie minimale sur les caillebotis de passerelle lorsqu'ils sont installés correctement• Tenue durable - ergots de verrouillage sur la coupelle pour éviter le desserrage ou la rotation



2 SYSTÈME DE FIXATION

	S-BT-GF M8/7 AN 6 HL	S-BT-GR M8/7 SN 6 HL	S-BT-GR M8/7 SN 6 HL AL	S-BT-MF M8/15 AN 6 HL	X-BT-GR M8/7 SN 8	X-ST-GR M8/10 P8
Fixation						
Matériau support	Acier	Acier	Aluminium	Acier	Acier	Acier
X-FCM-F L	■	■	■	■	■	■

- Recommandée pour combinaison
- Adapté à une combinaison

• Utilisation possible avec l'extension de goujon fileté X-SEA-R.

3 CONDITIONS D'APPLICATION

3.1 Applications

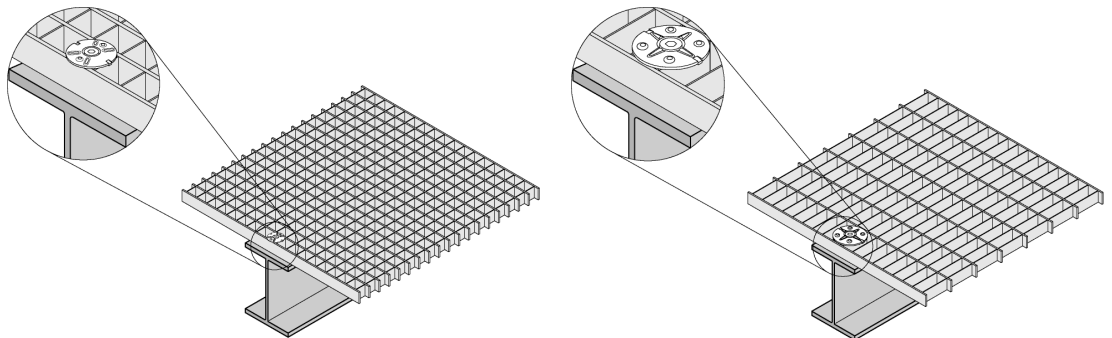

Fixation de caillebotis carré

Fixation de caillebotis rectangulaire

3.2 Matériau support

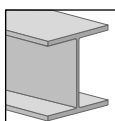

Acier

3.3 Conditions de charge

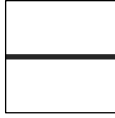

Statique/quasi statique

3.4 Conditions environnementales

X-FCM-F L combiné à S-BT-GF M8/7 AN 6 HL, S-BT-MF M8/15 AN 6 HL, X-ST-GR M8/10 P8

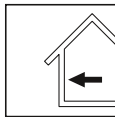

Intérieurs secs



Environnements intérieurs
avec condensation
temporaire

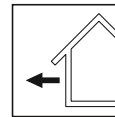

Environnement extérieur, rural
ou urbain avec faible pollution



Environnement extérieur, rural
ou urbain avec concentration
modérée de polluants et/ou
de sel d'eau de mer



Adapté à la prévention de la corrosion



Nécessite une évaluation par des spécialistes



• Pour plus de détails, reportez-vous au [manuel sur la corrosion Hilti](#)

4 HOMOLOGATIONS ET CERTIFICATS

Autorité	N° d'homologation/de certificat	Date d'émission
American Bureau of Shipping (ABS)	22-2285526-PDA	07.09.2022
Bureau Veritas (BV)	BV 71291/A0 EV	07.06.2023
Det Norske Veritas (DNV)	TAS00001UJ Rev. 4	22.08.2023



• Les informations présentées dans cette fiche technique produit sont basées sur les données techniques Hilti.
• Pour l'application spécifique, veuillez consulter l'homologation/certificat correspondant.

5 DONNÉES PRODUIT

5.1 Dimensions

X-FCM-F L

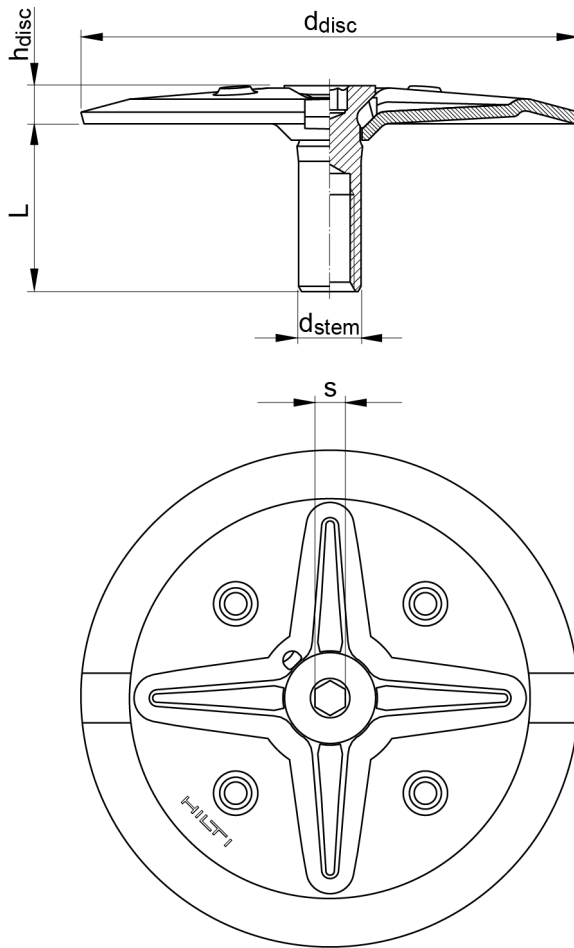

Désignation	Longueur	Diamètre du goujon	Diamètre du disque	Hauteur du disque	Largeur hex
	L [mm]	d _{stem} [mm]	d _{disc} [mm]	h _{disc} [mm]	s [mm]
X-FCM-F L 28/33	23	10,3	82	4	5
X-FCM-F L 32/37	27	10,3	82	4	5
X-FCM-F L 38/43	33	10,3	82	4	5
X-FCM-F L 48/53	43	10,3	82	4	5

5.2 Propriétés du matériau pour pièces en acier au carbone

Désignation	Élément	Matériau	Revêtement	Épaisseur du revêtement t_c [μm]	Catégorie de corrosivité
X-FCM-F L	Coupelle, goujon fileté	Acier au carbone	Revêtement en duplex		C3



- Catégorie de corrosivité de l'atmosphère selon la norme EN ISO 9223.
- Épaisseur du revêtement t_c : système de revêtement duplex équivalent à 45 μm de zinc galvanisé (durée d'essai au brouillard salin de 480 h selon la norme DIN EN ISO 9227).

5.3 Propriétés du matériau pour pièces plastiques

Désignation	Élément	Matériau	Couleur
X-FCM-F L	Joint torique d'absorbeur	Polyuréthane (PUR)	Noir

6 EXIGENCES EN MATIÈRE D'APPLICATION

6.1 Propriétés du matériau de caillebotis

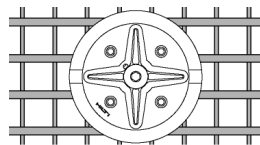

Type de caillebotis	Carré
Espacement de la barre dégagée $w_{\text{bearing bar}}$ [mm]	30 – 60
Espacement de la barre transversale $w_{\text{cross bar}}$ [mm]	30 – 60
Hauteur de caillebotis h_G [mm]	28 – 53
Hauteur de caillebotis h_G avec X-SEA [mm]	58 – 83

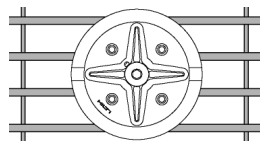

Type de caillebotis	Rectangulaire
Espacement de la barre dégagée $w_{\text{bearing bar}}$ [mm]	30 – 57
Hauteur de caillebotis h_G [mm]	28 – 53
Hauteur de caillebotis h_G avec X-SEA [mm]	58 – 83

6.2 Plages d'applications de fixations

- Les domaines d'application sont indiqués dans la ou les fiches techniques produits correspondants aux fixations.

6.3 Élément de caillebotis recommandé

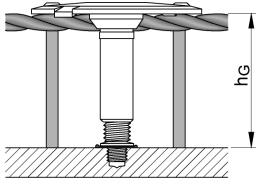

Désignation	Matériau de caillebotis	Type de caillebotis	Hauteur de caillebotis h_G [mm]
X-FCM-F L 28/33	Acier au carbone,	Carré, Rectangulaire	28-33
X-FCM-F L 32/37	Fibre de verre renforcée		32-37
X-FCM-F L 38/43			38-43
X-FCM-F L 48/53			48-53

6.4 Élément de caillebotis recommandé avec l'extension de goujon fileté X-SEA

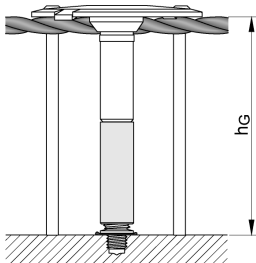

Désignation	Matériau de caillebotis	Type de caillebotis	Hauteur de caillebotis h_G [mm]
X-FCM-F L 28/33	Acier au carbone,	Carré, Rectangulaire	58-63
X-FCM-F L 32/37	Fibre de verre renforcée		62-67
X-FCM-F L 38/43			68-73
X-FCM-F L 48/53			78-83

7 DONNÉES DE PERFORMANCE

7.1 Charges recommandées

Désignation	Type de caillebotis	Espacement de la barre déagée	
		$w_{\text{bearing bar}}$ [mm]	N_{rec} [kN]
X-FCM-F L combiné à S-BT-GF M8/7 AN 6 HL, S-BT-MF M8/15 AN 6 HL	Rectangulaire	30	0,8
		57	0,8
	Carré	30	1,8
		60	0,8

Désignation	Type de caillebotis	Espacement de la barre déagée	
		$w_{\text{bearing bar}}$ [mm]	N_{rec} [kN]
X-FCM-F L combiné à X-ST-GR M8/10 P8	Rectangulaire	30	0,8
		57	0,8
	Carré	30	1,8
		60	0,8



- Ne convient pas à une conception avec charge de cisaillement explicite, p. ex. diaphragmes.
- La résistance au cisaillement par frottement dépend des caractéristiques de la surface.
- Les faibles charges de cisaillement inattendues peuvent être tolérées sans dommage.
- Les charges de cisaillement jusqu'à 0,3 kN ne causent pas de déformation permanente.

7.2 Méthode de calcul pour la résistance de conception

Type de charge	Équation	Facteur partiel de sécurité pour actions γ_f
Charge de traction	$N_{\text{Rd}} = N_{\text{rec}} \cdot \gamma_f$	1,4
Charge de cisaillement	$V_{\text{Rd}} = V_{\text{rec}} \cdot \gamma_f$	1,4

8 RECOMMANDATION SUR L'INSTALLATION

8.1 Recommandation sur l'outil de serrage

Désignation	Matériau support	Épaisseur du matériau support	Couple de serrage	Type d'outil	Type d'embrayage (détection d'arrêt)	Niveau de puissance de l'outil
		t_{II} [mm]	T_{rec} [Nm]			Vitesse / Embrayage
X-FCM-F L combiné à S-BT-GF M8/7 AN 6 HL, S-BT-MF M8/15 AN 6 HL	Acier	≥3	8	Calibrated torque wrench		
				X-BT 1/4" - 8 Nm		
				SBT 4-A22	TRC	1 / 7
				SBT 6-22	ESC (SJ)	1 / 7
				SF 18-A	TRC	1 / 5
				SF 2-A12	TRC	1 / 15
				SF 22-A	TRC	1 / 5
				SF 2H-A12	TRC	1 / 15
				SF 4-A22	TRC	1 / 8
				SF 6-A22	ESC (SJ)	1 / 7
				SF 6H-A22	ESC (SJ)	1 / 7
				SFC 18-A	TRC	1 / 5
				SFC 22-A	TRC	1 / 5

Désignation	Matériau support	Épaisseur du matériau support	Couple de serrage	Type d'outil	Type d'embrayage (détection d'arrêt)	Niveau de puissance de l'outil
		t_{II} [mm]	T_{rec} [Nm]			Vitesse / Embrayage
X-FCM-F L combiné à X-ST-GR M8/10 P8	Acier	≥6	8	Calibrated torque wrench		
				X-BT 1/4" - 8 Nm		
				SBT 4-A22	TRC	1 / 7
				SBT 6-22	ESC (SJ)	1 / 7
				SF 18-A	TRC	1 / 5
				SF 2-A12	TRC	1 / 15
				SF 22-A	TRC	1 / 5
				SF 2H-A12	TRC	1 / 15
				SF 4-A22	TRC	1 / 8
				SF 6-A22	ESC (SJ)	1 / 7
				SF 6H-A22	ESC (SJ)	1 / 7
				SFC 18-A	TRC	1 / 5
				SFC 22-A	TRC	1 / 5



- Embrayage à friction électronique (ESC) : ESC a 2 détections d'arrêt, un joint souple (SJ) et un joint dur (HJ). La détection du joint dur est activée en cas d'une baisse de la vitesse (arrêt rapide) et peut entraîner un pic de couple.
- Accouplement temporaire (TRC) : le couple réalisable peut changer progressivement en raison de l'usure de l'embrayage.

9 INFORMATION DE COMMANDE

9.1 N° d'article et description

Désignation	Code d'article	Description
X-FCM-F L 28/33	2354532	X-FCM-F L Grande coupelle de fixation pour caillebotis (revêtement duplex)
X-FCM-F L 32/37	2354533	
X-FCM-F L 38/43	2354534	
X-FCM-F L 48/53	2354535	
S-BT-GF M8/7 AN 6 HL	2345766	S-BT-GF HL Goujon fileté
S-BT-MF M8/15 AN 6 HL	2345769	S-BT-MF HL Goujon fileté
X-ST-GR M8/10 P8	2122460	X-ST-GR M8



Hilti Aktiengesellschaft
9494 Schaan, Liechtenstein
P +423-234 2965

www.facebook.com/hiltigroup
www.hilti.group