

HILTI

DX 460 SM

Operating instructions

en

Mode d'emploi

fr

Manual de instrucciones

es

Инструкция по эксплуатации

ru



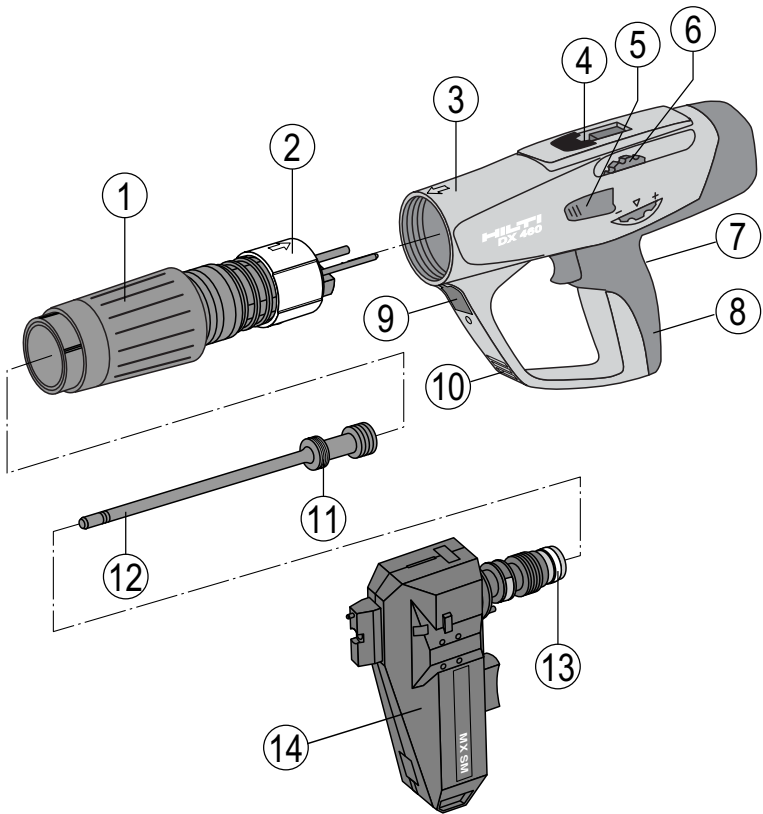

6.2

①

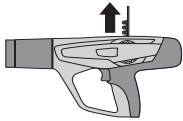

③

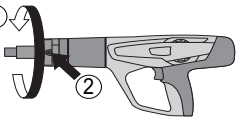

④

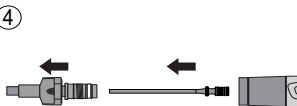

⑤



⑥

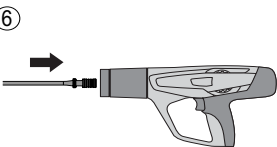

⑦

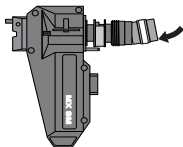

⑧

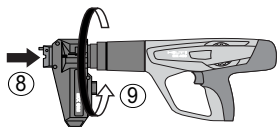

6.3

①

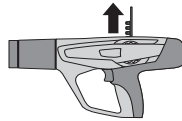

③

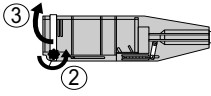

④

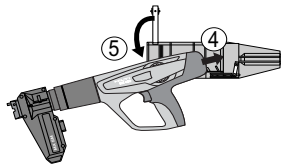

⑥

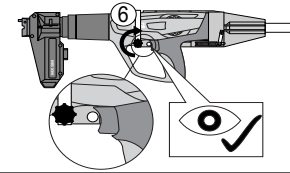

⑦

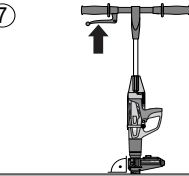

⑧

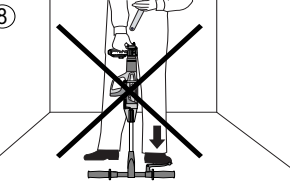

7.1

①

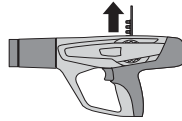

②

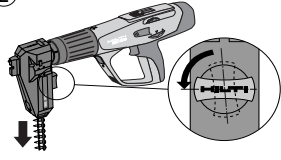

③

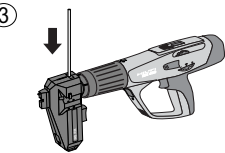

④

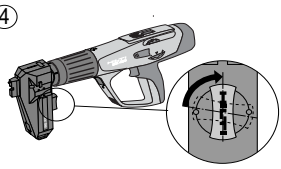

⑤

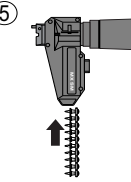

⑥

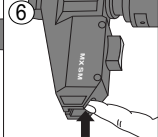

7.2

①

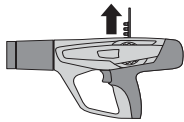

②

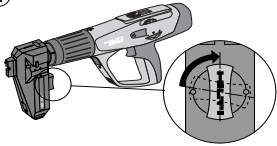

③



④

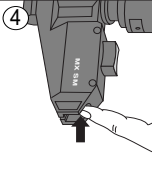

⑤

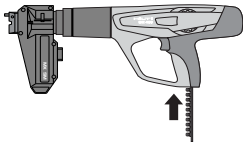

⑩

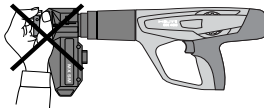

⑪

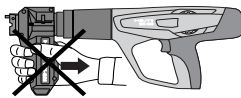

8.3

①

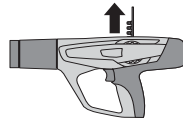

③

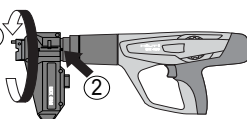

②

8.4

①

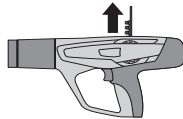

④

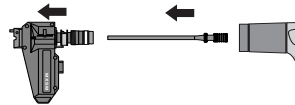

③

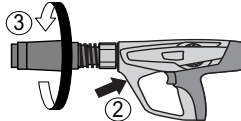

⑤

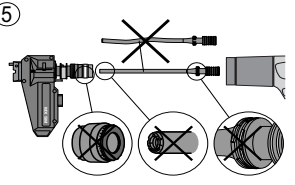

max
min

⑦

⑥



④

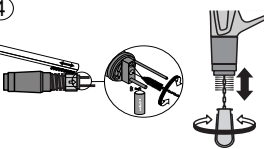

⑥

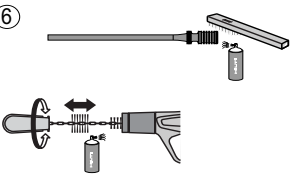

⑧

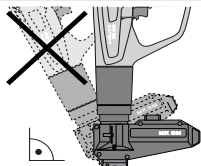

⑤

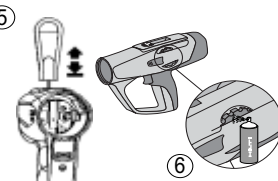

⑦

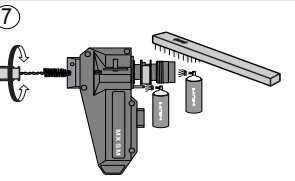

⑨

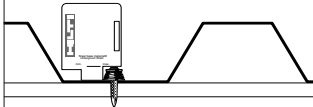

⑦

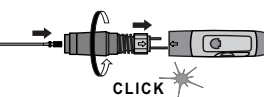

CLICK

DX 460 SM powder-actuated tool

It is essential that the operating instructions are read before the tool is operated for the first time.

Always keep these operating instructions together with the tool.

Ensure that the operating instructions are with the tool when it is given to other persons.

Description of main parts

- ① Gas return unit
- ② Guidance sleeve
- ③ Housing
- ④ Cartridge channel
- ⑤ Unlock key power regulation wheel
- ⑥ Power regulation wheel
- ⑦ Trigger
- ⑧ Handle
- ⑨ Unlock key gas return unit
- ⑩ Aeration slots
- ⑪ Piston rings
- ⑫ Piston X-460-PSM (# 373303)
- ⑬ Buffer X-460-B (# 373 330)
- ⑭ Magazine MX SM (# 370 827)

* These parts may be replaced by the user/operator.

Contents	Page
1. Safety rules	1
2. General information	2
3. Description	3
4. Accessories	4
5. Technical data	6
6. Before use	6
7. Operation	7
8. Care and maintenance	8
9. Malfunctions, remedies and troubleshooting	9
10. Disposal	11
11. Manufacturer's warranty – DX tools	12
12. EC declaration of conformity (original)	12
13. CIP approval mark	12
14. Health and safety of the user	13

1. Safety rules

1.1 Basic safety instructions

In addition to the safety rules listed in the individual sections of these operating instructions, the following points must be strictly observed at all times.

1.2 Only use Hilti cartridges or cartridges of equivalent quality

The use of cartridges of inferior quality in Hilti tools may lead to build-up of unburned powder, which may explode and cause severe injuries to operators and bystanders. At a minimum, cartridges must either:

a) Be confirmed by their supplier for successful testing according to EU standard EN 16264

NOTE:

- All Hilti cartridges for powder-actuated tools have been tested successfully in accordance with EN 16264.
- The tests defined in the EN 16264 standard are system tests carried out by the certification authority using specific combinations of cartridges and tools. The tool designation, the name of the certification authority and the system test number are printed on the cartridge packaging.

or

b) Carry the CE conformity mark (mandatory in the EU as of July 2013).

See packaging sample at:
www.hilti.com/dx-cartridges

1.3 Use as intended

The tool is designed for professionals for fastening profiled metal roof and floor decking to open web steel joists.



1.4 Improper use

- Manipulation or modification of the tool is not permissible.
- Do not operate the tool in an explosive or flammable atmosphere, unless the tool is approved for such use.
- To avoid the risk of injury, use only original Hilti fasteners, cartridges, accessories and spare parts or those of equivalent quality.
- Observe the information printed in the operating instructions concerning operation, care and maintenance.
- Never point the tool at yourself or any bystander.
- Never press the muzzle of the tool against your hand or other part of your body.
- Do not drive nails into materials like glass, marble, plastic, bronze, brass, copper, natural rock, insulation

en

material, hollow brick, glazed tile, thin-gauge sheet metal (< 4 mm), grey cast iron, spheroidal cast iron and gas concrete.

1.5 Technology

- This tool is designed with the latest available technology.
- The tool and its ancillary equipment may present hazards when used incorrectly by untrained personnel or not as directed.



1.6 Making the workplace safe

- Ensure that the workplace is well lit.
- Wear non-slip shoes and always work from a secure stance.
- Avoid unfavorable body positions. Work from a secure stance and stay in balance at all times.
- Ensure that the workplace is well lit.
- Operate the tool only in well-ventilated working areas.
- Objects which could cause injury should be removed from the working area.
- The tool is for hand-held use only.
- Keep other persons, children in particular, outside the working area.
- Before using the tool, make sure that no one is standing behind or below the point where fasteners are to be driven.
- Keep the grip dry, clean and free from oil and grease.



1.7 General safety precautions

- Operate the tool only as directed and only when it is in faultless condition.
- Use the stabilizer/splinter guard when the application permits.
- If a cartridge misfires or fails to ignite, proceed as follows:
 1. Keep the tool pressed against the working surface for 30 seconds.
 2. If the cartridge still fails to fire, withdraw the tool from the working surface, taking care that it is not pointed towards your body or bystanders.
 3. Manually advance the cartridge strip one cartridge. Use up the remaining cartridge on the strip. Remove the used cartridges strip and dispose of it in such a way that it can be neither reused nor misused.
- Never attempt to pry a cartridge from the magazine strip or the tool.
- Keep the arms flexed when the tool is fired (do not straighten the arms).
- Never leave the loaded tool unattended.
- Always unload the tool before beginning cleaning, servicing or changing parts and before storage.

- Store cartridges and unused tools unloaded, in a dry, high or locked place out of the reach of children.



1.8 Temperature

- Do not disassemble the tool while it is hot.
- Never exceed the recommended maximum fastener driving rate (number of fastenings per hour). The tool may otherwise overheat.
- Should the plastic cartridge strip begin to melt, stop using the tool immediately and allow it to cool down.

1.9 Requirements to be met by users

- The tool is intended for professional use.
- The tool may be operated, serviced and repaired only by authorized, trained personnel. This personnel must be informed of any special hazards that may be encountered.
- Proceed carefully and do not use the tool if your full attention is not on the job.
- Stop working with the tool if you feel unwell.

1.10 Personal protective equipment



- The operator and other persons in the immediate vicinity must always wear eye protection, a hard hat and ear protection.

2. General information

2.1 Indication and possible danger

WARNING

The word WARNING is used to draw attention to a potentially dangerous situation which could lead to severe personal injury or death.

CAUTION

The word CAUTION is used to draw attention to a potentially dangerous situation which could lead to minor personal injury or damage to the equipment or other property.

2.2 Pictograms

Warning signs



General warning



Warning: hot surface

Symbols



Read the operation instructions before use

Obligation signs



Wear eye protection



Wear a safety helmet



Wear ear protection

1 The numbers refer to the illustrations. The illustrations can be found on the fold-out cover pages. Keep these pages open while you read the operating instructions.

In these operating instructions, the designation “the tool” always refers to the DX 460 SM powder-actuated tool.

Location of identification data on the tool

The type designation and the serial number are printed on the type plate on the tool. Make a note of this information in your operating instructions and always refer to it when making an inquiry to your Hilti representative or service department.

Type: DX 460 SM

Serial no.: _____

3. Description

The Hilti DX 460 tool with a MX SM fastener magazine is a powder-actuated tool designed for fastening profiled metal roof and floor decking to open web steel joists. The tool hammers the fasteners into the base material by using expanding gases to propel a captive steel piston against the fastener. As a result of this piston principle, the tool is classified as low velocity.

The piston is returned to the starting position and the cartridges are fed into the firing chamber automatically by gas pressure from the fired cartridge. This enables the user to fasten very quickly and economically at a rate of up to 700 fastenings per hour.

The tool has not been approved for use in an explosive atmosphere.

Additional equipment for a wide range of other applications (e.g. fastening timber to concrete) is available on request. Please contact your local Hilti representative. As with all powder-actuated tools, the DX 460, the MX SM magazine, the fasteners and the cartridges form a “technical unit”. This means that trouble-free fastening with this system can only be assured if the fasteners and cartridges specially manufactured for the tool, or products of an equivalent quality, are used. The fasteners and application recommendations given by Hilti are only applicable if this condition is observed.

The tool features 5-way safety – for the safety of the operator and bystanders.

The piston principle

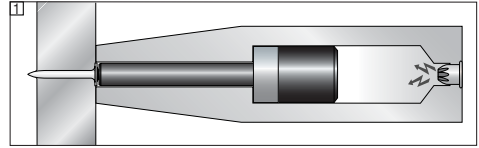

The energy from the propellant charge is transferred to a piston, the accelerated mass of which drives the fastener into the base material. As approximately 95 % of the kinetic energy is absorbed by the piston, the fastener is driven into the base material at much reduced velocity (less than 100 m/sec.) in a controlled manner. The driving process ends when the piston reaches the end of its travel. This makes dangerous through-shots virtually impossible when the tool is used correctly.

The drop-firing safety **2** device is the result of coupling the firing mechanism with the cocking movement. This prevents the Hilti DX tool from firing when it is dropped onto a hard surface, no matter at which angle the impact occurs.

The trigger safety device **3** ensures that the cartridge cannot be fired simply by pulling the trigger only. The tool can be fired only when pressed against the work surface.

The contact pressure safety device **4** requires the tool to be pressed against a firm surface with a significant force. The tool can be fired only when pressed fully against the work surface in this way.

In addition, all Hilti DX tools are equipped with an unintentional firing safety device **5**. This prevents the tool from firing if the trigger is pulled and the tool then pressed against the work surface. The tool can be fired only when it is first pressed (1.) against the work surface correctly and the trigger then pulled (2.).

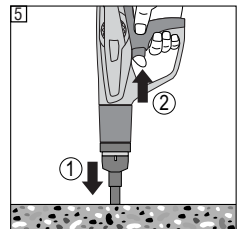
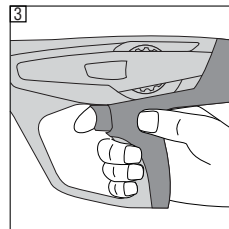
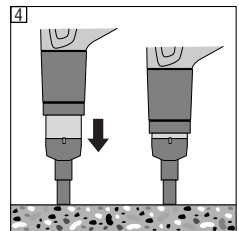
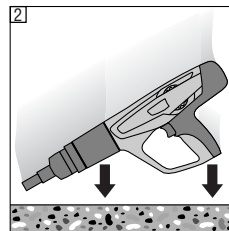

en

4. Cartridges, accessories and fasteners

Cartridges

Ordering designation	Colour code	Power level
6.8/11 M (.27 cal short) (3/220 MA)	red	heavy
6.8/11 M (.27 cal short) (3/220 MA)	purple	extra heavy

Typical application restrictions

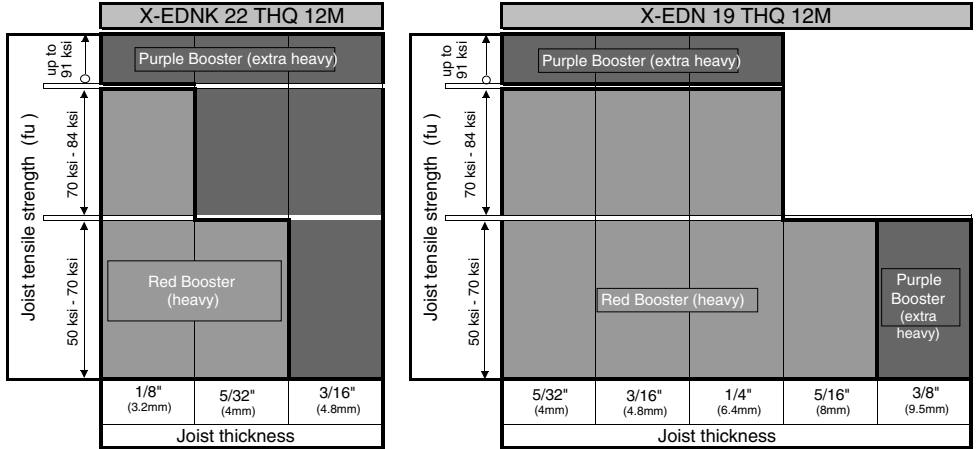

* Due to variations in site conditions, site testing required.

Note:

Refer to the nail/cartridge selector chart for more detail information. Contact your local Hilti marketing organization for technical support with diaphragm design calculations and project submittals.

Fastener program:

For approval relevant roof and floor decking applications (SDI, ICBO, FM, UL approved):

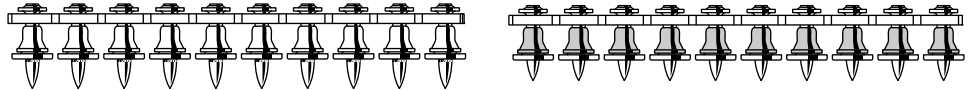

Article no.	Ordering designation	Application description
34133	X-EDNK 22 THQ12M	base material thickness $1/8'' - 3/16''$ (3.2–4.8 mm)
34134	X-EDN 19 THQ 12M	base material thickness $5/32'' - 3/8''$ (4–9.5 mm)

For non-critical form deck applications:

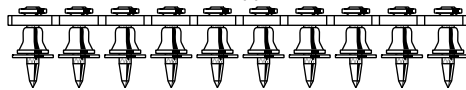

Article no.	Ordering designation	Application description
332586	X-ZF 22 THS 12M	base material thickness $1/8'' - 1/4''$ (3.2–6.4 mm)

Fastening guidelines

For more specific information, refer to the Product Technical Guide, which is available from your local Hilti organization or if necessary, your national technical regulations.

Note: The MX SM magazine and associated fasteners are only suitable for fastenings on steel!

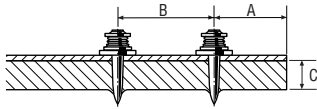

Steel:

A = min. edge distance = 10 mm ($\frac{3}{8}$ ")

B = min. spacing = 20 mm ($\frac{3}{4}$ ")

C = min. base material thickness = 3.2 mm ($\frac{1}{8}$ ")

en

Check nail head-standoff (use the supplied nail head standoff templates)

X-EDNK 22 THQ 12M (HSN 22)

X-EDN 19 THQ 12M (HSN 19)

X-ZF 22 THS 12M (FDN 22)

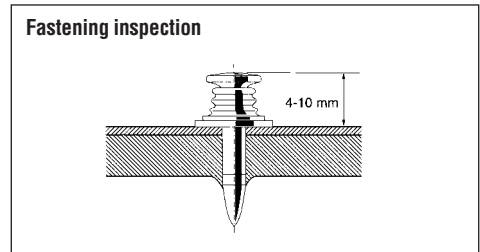
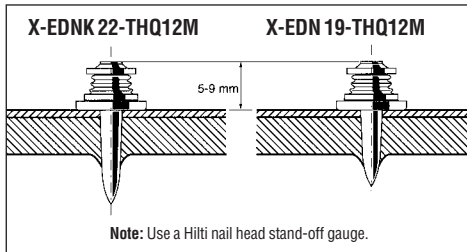

Piston

Article no.	Ordering designation	Application description
373303	X-460-PSM	Standard piston for HSN and FDN pins.

Accessory

Article no.	Ordering designation	Application description
373330	X-460-B	Buffer; does not fit the DX A41 SM tool
370831	X-SH 460	Standup handle for DX 460 SM

Cleaning set

Hilti spray, Ramrod, Flat brush, Round brush big, Round brush small, Scraper, Cleaning cloth

5. Technical data

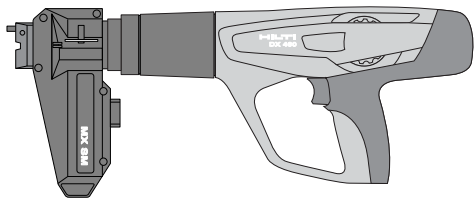

Tool DX 460 SM

Weight:	3.96 kg (8.50 lb)
Tool length	472 mm
Nail length	max. 22 mm
Cartridges	6.8/11 M (.27 cal short) red, purple
Magazine capacity	10 nails
Power regulation	4 power levels

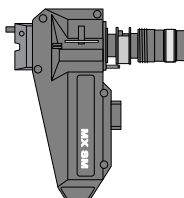

Magazine MX 72

Weight	0.98 kg (2.15 lb)
Nail length	max. 22 mm
Magazine capacity	10 nails
Nails	X-EDNK 22 THQ 12M (HSN 22) X-EDN 19 THQ 12M (HSN 19) X-ZF 22 THS 12M (FDN 22)

Right of technical changes reserved

6. Before use



6.1 Tool inspection

- Ensure that there is no cartridge strip in the tool. If there is a cartridge strip in the tool, remove it by hand from the tool.
- Check all external parts of the tool for damage at regular intervals and check that all controls operate properly. Do not operate the tool when parts are damaged or when the controls do not operate properly. If necessary, have the tool repaired at a Hilti service centre.
- Check the buffer and piston for wear (see 8. Care and maintenance).

6.2 Fitting the MX SM magazine to an existing DX 460 tool.

1. Ensure that there is no cartridge strip in the tool. If there is a cartridge strip in the tool, remove it by hand from the tool.
2. When fitting the magazine to an existing DX 460 tool press the unlock key.
3. Unscrew the fastener guide of the single tool.
4. Remove the fastener guide with buffer and the piston. Store these parts separately – they must not be used together with the MX SM fastener magazine.
5. Use only the X-460-PSM piston. The designation is marked on the piston in the position shown in the picture.
6. Insert the X-460-PSM piston into the tool and push it backwards as far as it will go.
7. Push a reinforced stop buffer X-460-B onto the MX SM fastener magazine.

Note: Always use the tool with the buffer in place to avoid damage to the tool.

8. Firmly press the XM SM fastener magazine on the gas return unit of the tool.
9. Fully screw the magazine on the tool until it clicks into place.

Note: The MX SM fastener magazine must only be used with a DX 460 tool.

6.3 Fitting the DX 460 SM to the standup handle X-SH 460

1. Ensure that there is no cartridge strip in the tool. If there is a cartridge strip in the tool, remove it by hand from the tool.
2. Unscrew the knurled screw on the tool casing of the standup handle X-SH 460
3. Open the metal clamping bar.
4. Insert the DX 460 tool into the handle casing.
5. Secure the DX 460 tool with the clamping bar
6. Tightening the clamping bar with the knurled screw

Note: The firing lever must be positioned in front of the trigger.

7. When fastening, position the handle with the tool at right angles to the working surface, press down the handle X-SH 460 and then pull the trigger.
8. **Warning:** Never operate the handle with the DX 460 tool up side down!

Note: The disassembly of the standup handle works in the reverse order, starting with pulling the cartridge strip out of the tool.

7. Operation



CAUTION	
 	<ul style="list-style-type: none"> ■ The base material may splinter when a fastener is driven or fragments of the cartridge strip may fly off. ■ Flying fragments may injure parts of the body or the eyes. ■ Wear eye protection and a hard hat (users and bystanders).

CAUTION	
	<ul style="list-style-type: none"> ■ The nail or stud is driven by a cartridge being fired. ■ Excessive noise may damage the hearing. ■ Wear ear protection (users and bystanders).

WARNING	
	<ul style="list-style-type: none"> ■ The tool is ready to fire when it is pressed against a part of the body (e.g. hand). ■ This could cause a nail to be driven into a part of the body. ■ Never press the muzzle of the tool against parts of the body.

WARNING	
	<p>Under certain circumstances, the tool can be ready to fire when the magazine is pulled back by hand.</p> <ul style="list-style-type: none"> ■ This could cause a nail to be driven into a part of the body. ■ Never pull the magazine back by hand.

7.1 Unload / Reload the MX SM fastener magazine

1. Ensure that there is no cartridge strip in the tool. If there is a cartridge strip in the tool, remove it by hand from the tool.
2. To unload unused fasteners turn the unload button at a right angle position to the magazine. Allow the fasteners to drop out.
3. If fasteners become jammed in the magazine, use the supplied ram-rod in the opening on top of the MX SM magazine, to push the fasteners out.
Note: Use only the supplied ram-rod. Using a screw driver or any other tool may damage the magazine mechanism.
4. Ensure the load/unload button is turned in line with the MX SM magazine.
5. Push in the fastener strip.
6. The fastener strip must be pushed in as far as it will go.

7.2 Loading consumables and making fastenings

1. Ensure that there is no cartridge strip in the tool. If there is a cartridge strip in the tool, remove it by hand from the tool.
2. Ensure the load/unload button is turned in line with the MX SM magazine.
3. Push in the fastener strip.
4. The fastener strip must be pushed in as far as it will go.
5. Load the cartridge strip narrow end first by inserting it into the bottom of the tool grip until flush.
Note: If the strip has been partly used, pull it through until a live cartridge is in the cartridge chamber.
6. Adjust the fastener driving power by pressing the unlock power regulator key
7. Turn the power regulator wheel
1= minimum power
4= maximum power
Note: Start with minimum power. If the fastener does not penetrate deep enough, increase the driving power.
8. Use the supplied nail standoff-template to check the correct penetration depth.
9. When fastening, position the tool at right angles to the working surface, press down and then pull the trigger.
Note: Never fasten through an existing hole. Never re-drive fasteners.
10. **Warning:** Never push back the front of the tool with the palm of the hand!
11. **Caution:** Never pull back the MX SM magazine by hand, because this would constitute an accident hazard!

en

8. Care and maintenance

8.1 Care of the tool

The outer casing of the tool is manufactured from impact-resistant plastic. The grip comprises a synthetic rubber section.

The ventilation slots must be unobstructed and kept clean at all times. Do not permit foreign objects to enter the interior of the tool. Use a slightly damp cloth to clean the outside of the tool at regular intervals. Do not use a spray or steam-cleaning system for cleaning.

8.2 Maintenance

Check all external parts of the tool for damage at regular intervals and check that all controls operate properly. Do not operate the tool when parts are damaged or when the controls do not operate properly. If necessary, have the tool repaired at a Hilti service center.

CAUTION	
	<ul style="list-style-type: none">■ The tool can get hot while operating.■ You could burn your hands.■ Do not disassemble the tool while it is hot. Let the tool cool down.

Servicing the tool if:

1. Cartridge misfires or
2. Driving power is inconsistent
3. If you notice:
 - Increased contact pressure
 - Increased trigger force
 - Power regulation hard to adjust
 - Cartridge strip is difficult to remove

CAUTION while cleaning the tool:

- Never use grease for maintenance/lubrication of tool parts. This may strongly affect the functionality of the tool. Use only Hilti spray or such of equivalent quality.
- Dirt from DX tool contains substances that could be endangering your health.
 - Do not breath in the dust from cleaning
 - Keep dust away from food
 - Wash your hands after cleaning the tool

8.3 Daily maintenance and inspection / Cleaning and servicing (minor service)

1. Ensure that there is no cartridge strip in the tool. If there is a cartridge strip in the tool, remove it by hand from the tool.
2. To disassemble the DX 460 SM tool push down the small locking button
3. Unscrew the MX SM fastener magazine
4. Pull the MX SM magazine with the buffer and the piston out of the tool.

Note: If the piston sticks in the tool, the entire piston guide must be unlocked and unscrewed. (see “Mal-

functions and remedies”). Then push out the piston through the cartridge chamber by using the supplied ram-rod.

5. Check the buffer and the piston for wear
 - Replace the buffer X-460B** by bending it to separate it from the magazine if
 - the metal ring is loose or broken
 - it stays no longer on the magazine interface
 - excessive uneven wear under the metal ring
 - Replace the piston X-460-PSM** if it shows signs of wear
 - it is broken, it has cracks
 - the tip is heavily worn (e.g. a 90 degree segment is chipped off)
 - it is bent (check through rolling on an even surface)
 - Note:** Do not use worn piston and do not manipulate the piston.
 6. Clean the piston and gas return unit
 - clean the piston rings with the supplied flat wire brush
 - spray the piston rings slightly with Hilti spray
 - clean the exhaust gas return unit inside using the supplied big round brush.
 - spray the gas return unit slightly with Hilti spray
 7. Clean the MX SM fastener magazine
 - separate the buffer from the MX SM fastener magazine by bending
 - clean the magazine outside using the supplied flat wire brush
 - clean the magazine inside using the supplied small round brush.
- Note:** It is important to clean out any small fragments of the plastic strip from the magazine fastener guide. Spray the transport slider and the magazine thread slightly with Hilti spray.
- Note:** Spraying oil onto the rubber buffer should be avoided.

8.4 Cleaning and servicing (major service)

Note: A major service should be carried out every 10.000 fastenings or when a piston sticks in the piston guide. First carry out the minor service as described in point 8.3, then:

1. Ensure that there is no cartridge strip in the tool. If there is a cartridge strip in the tool, remove it by hand from the tool.
2. To disassemble the exhaust gas return unit from the DX 460 SM tool unlock the push button on the grip section of the tool
3. Unscrew the exhaust gas return unit
4. Clean the exhaust gas return unit
 - clean the spring of the gas return with the supplied flat brush
 - clean the temperature sleeve with the flat brush
 - clean the two holes in the cartridge chamber at the end-face using the small round brush.
 - clean the inside of the gas return unit using the big round brush
 - spray the gas return unit slightly (spring, cartridge chamber and the housing inside) with Hilti spray.

5. Clean the left and right-hand cartridge strip guideway, using the enclosed scraper.
6. Spray the power regulation wheel slightly with spray.
7. Assemble the exhaust gas return unit
 - the arrow on the red housing and the arrow on the temperature sleeve of the gas return unit must align to

- push the gas return unit back in the red plastic tool housing.
- screw the gas return unit onto the tool until it clicks into place (button on the grip of the tool).

9. Malfunctions, remedies and troubleshooting

Malfunctions:

Malfunction	Elimination
Misfires:	See "Cartridge misfire" (see point 5.6 under safety precautions)

Remedies:

Warning: Always remove the cartridge strip from the tool before tackling the malfunctioning described below.

Repeated misfires:	Carry out the major service.
Very large drop in driving power or very different depths of penetration:	Carry out the major service. If the tool then still displays big variations in driving power or penetration depths, please contact your Hilti representative.
Piston does not return when the joist or beam is missed:	Pull the cartridge strip out of the tool. Push back the piston using the original Hilti supplied ram-rod and then press the tool down once or twice against the decking to feed a new nail into the magazine.
Magazine tool cannot be fired / magazine firing detent comes into action (despite having nails in the magazine):	Unload the remaining nails. Clean inside the fastener guide using the small round brush. Plastic fragments could be blocking the nail detection mechanism.
The piston sticks in the piston guide and cannot be pulled out:	Unscrew the exhaust gas piston return unit (see major service / point 8.4). Push out the piston through the cartridge chamber using the supplied ramrod. The piston could be jammed by rubber buffer fragments or excessive dirt.
Debris becomes stuck in the fastener guide of the magazine:	Pull the cartridge strip out of the tool. Unload unused fasteners. Unload the remaining nails. Remove the magazine from the tool and use the piston to drive out the jammed fastener.
Buffer wears too quickly:	Mark the joist position clearly to avoid missing.
Nail feed problems:	Lubricate the transport sliders (see minor service / point 8.3)

Troubleshooting

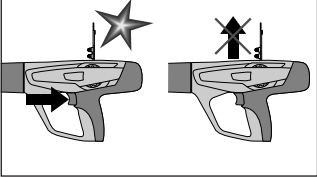
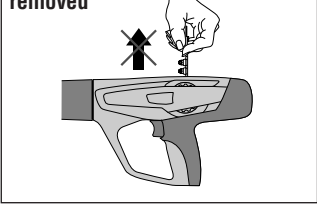
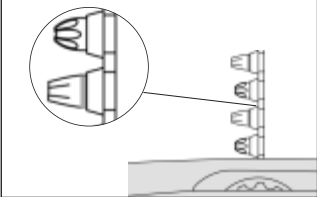
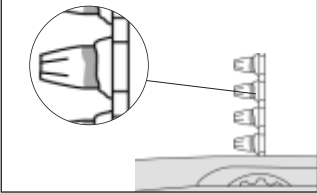
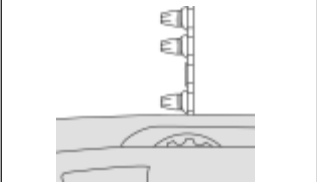
Fault	Cause	Possible remedial measure
<p>en Cartridge not transported</p> 	<ul style="list-style-type: none"> ■ Damaged cartridge strip ■ Carbon build up ■ Tool damaged 	<ul style="list-style-type: none"> ■ Change cartridge strip ■ Clean the cartridge strip guide-way (see 8.4, point 5) <p>If the problem persists:</p> <ul style="list-style-type: none"> ■ Contact Hilti Center.
<p>Cartridge strip cannot be removed</p> 	<ul style="list-style-type: none"> ■ Tool overheated because of high setting rate ■ Tool damaged <p>WARNING Make sure not to crush or pry on an unfired booster.</p>	<ul style="list-style-type: none"> ■ Let the tool cool down ■ Then carefully try to remove the cartridge strip <p>If not possible:</p> <ul style="list-style-type: none"> ■ Contact Hilti Center.
<p>Cartridge cannot be fired</p> 	<ul style="list-style-type: none"> ■ Bad cartridge ■ Carbon build up <p>WARNING Never attempt to pry a cartridge from the magazine strip of the tool.</p>	<ul style="list-style-type: none"> ■ Manually advance the cartridge strip one cartridge ■ If the problem occurs more often: Clean the tool <p>If the problem persists:</p> <ul style="list-style-type: none"> ■ Contact Hilti Center.
<p>Cartridge strip melts</p> 	<ul style="list-style-type: none"> ■ Tool is compressed too long while fastening. ■ Fastening frequency is too high 	<ul style="list-style-type: none"> ■ Compress the tool a shorter time while fastening. ■ Remove the cartridge strip ■ Disassemble the gas return unit (see 8.4) for fast cooling and to avoid possible damage <p>If the tool cannot be disassembled:</p> <ul style="list-style-type: none"> ■ Contact Hilti Center.
<p>Cartridge falls out of the cartridge strip</p> 	<ul style="list-style-type: none"> ■ Fastening frequency is too high <p>WARNING Make sure not to crush or pry on an unfired booster</p>	<ul style="list-style-type: none"> ■ Immediately discontinue using the tool and let it cool down ■ Remove cartridge strip ■ Let the tool cool down. ■ Clean the tool and remove loose cartridge. <p>If it is impossible to disassemble the tool:</p> <ul style="list-style-type: none"> ■ Contact Hilti Center.

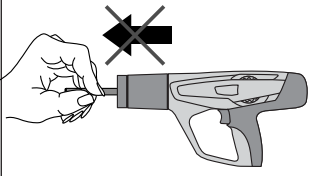
Fault	Cause	Possible remedial measure
<p>The operator notices:</p> <ul style="list-style-type: none"> - increased contact pressure - increased trigger force - power regulation stiff to adjust - cartridge strip is difficult to remove 	<ul style="list-style-type: none"> ■ Carbon build up 	<ul style="list-style-type: none"> ■ Check that the correct cartridges are used (see 1.2) and that they are in faultless condition.
<p>Piston is stuck in the gas return unit and cannot be removed</p> 	<ul style="list-style-type: none"> ■ Damaged piston ■ Buffer debris inside the gas return unit ■ Damaged buffer ■ Carbon build-up 	<ul style="list-style-type: none"> ■ Remove the cartridge strip and clean the tool (see 8.3-8.14). Check the piston and buffer and replace these parts if necessary (see 8.4). <p>If the problem persists:</p> <ul style="list-style-type: none"> ■ Contact Hilti Center.

10. Disposal

Most of the materials from which Hilti power actuated tools are manufactured can be recycled. The materials must be correctly separated before they can be recycled. In many countries, Hilti has already made arrangements for taking back your old powder actuated tools for recycling. Please ask your Hilti customer service department or Hilti sales representative for further information. Should you wish to return the power actuated tool yourself to a disposal facility for recycling, proceed as follows: Dismantle the tools as far as possible without the need for special tools.

Separate the individual parts as follows:

Part / assembly	Main material	Recycling
Toolbox	Plastic	Plastics recycling
Outer casing	Plastic / synthetic rubber	Plastics recycling
Screws, small parts	Steel	Scrap metal
Used cartridge strip	Plastic / steel	According to local regulations

11. Manufacturer's warranty – DX tools

Hilti warrants that the tool supplied is free of defects in material and workmanship. This warranty is valid so long as the tool is operated and handled correctly, cleaned and serviced properly and in accordance with the Hilti Operating Instructions, and the technical system is maintained. This means that only original Hilti consumables, components and spare parts, or other products of equivalent quality, may be used in the tool.

This warranty provides the free-of-charge repair or replacement of defective parts only over the entire lifespan of the tool. Parts requiring repair or replacement as a result of normal wear and tear are not covered by this warranty.

Additional claims are excluded, unless stringent national rules prohibit such exclusion. In particular, Hilti is

not obligated for direct, indirect, incidental or consequential damages, losses or expenses in connection with, or by reason of, the use of, or inability to use the tool for any purpose. Implied warranties of merchantability or fitness for a particular purpose are specifically excluded.

For repair or replacement, send tool or related parts immediately upon discovery of the defect to the address of the local Hilti marketing organization provided.

This constitutes Hilti's entire obligation with regard to warranty and supersedes all prior or contemporaneous comments and oral or written agreements concerning warranties.

12. EC declaration of conformity (original)

Designation:	Powder-actuated tool
Type:	DX 460
Year of design:	2001

We declare, on our sole responsibility, that this product complies with the following directives and standards: 2006/42/EC, 2011/65/EU.

**Hilti Corporation, Feldkircherstrasse 100,
FL-9494 Schaan**



Norbert Wohlwend
Head of Quality & Processes Management
BU Direct Fastening
08/2012

Tassilo Deinzer
Head BU Measuring Systems
BU Measuring Systems
08/2012

Technical documentation filed at:
Hilti Entwicklungsgesellschaft mbH
Zulassung Elektrowerkzeuge
Hiltistrasse 6
86916 Kaufering
Deutschland

13. CIP approval mark

The following applies to C.I.P. member states outside the EU and EFTA judicial area:

The Hilti DX 460 has been system and type tested. As a result, the tool bears the square approval mark showing approval number S 812. Hilti thus guarantees compliance with the approved type.

Unacceptable defects or deficiencies, etc. determined during use of the tool must be reported to the person responsible at the approval authority (PTB, Braunschweig) and to the Office of the Permanent International Commission (C.I.P.) (Permanent International Commission, Avenue de la Renaissance 30, B-1000 Brussels, Belgium).

14. Health and safety of the user

Noise information

Powder-actuated tool

Type:	DX 460
Modell:	Serial production
Caliber:	6.8/11 black
Power setting:	2
Application:	Fastening 24 mm thick wood to concrete (C40) with X-U 47P8

en

Declared measured values of noise characteristics according to 2006/42/EC Machinery Directive in conjunction with E DIN EN 15895

Noise (power) level:	$L_{WA, 1s}^1$	105 dB(A)
Emission noise-pressure level in the work station:	$L_{pA, 1s}^2$	101 dB(A)
Peak sound pressure emission level:	$L_{pC, peak}^3$	133 dB(C)

Operation and set-up conditions:

Set-up and operation of the pin driver in accordance with E DIN EN 15895-1 in the semi-anechoic test room of Müller-BBM GmbH. The ambient conditions in the test room conform to DIN EN ISO 3745.

Testing procedure:

Enveloping surface method in anechoic room on reflective surface area in accordance with E DIN EN 15895, DIN EN ISO 3745 and DIN EN ISO 11201.

NOTE: The noise emissions measured and the associated measurement uncertainty represent the upper limit for the noise values to be expected during the measurements.

Variations in operating conditions may cause deviations from these emission values.

¹ ± 2 dB (A) / ² ± 2 dB (A) / ³ ± 2 dB (C)

Vibration

The declared total vibration value according to 2006/42/EC does not exceed 2.5 m/s².

Further information regarding the health and safety of the user can be found at the Hilti web site: www.hilti.com/hse



Hilti Corporation

LI-9494 Schaan

Tel.: +423 / 234 21 11

Fax: +423 / 234 29 65

www.hilti.com

Hilti = registered trademark of Hilti Corp., Schaan

W 2713 | 0713 | 10-Pos. 3 | 1

Printed in Liechtenstein © 2013

Right of technical and programme changes reserved S. E. & O.

371686 / A3



371686