



C 4/36-90  
C 4/36-350  
C 4/36-DC

English



**C 4/36-90**

**C 4/36-350**

**C 4/36-DC**

**Original operating instructions**



## 1 Information about the documentation

### 1.1 About this documentation

- Read this documentation before initial operation or use. This is a prerequisite for safe, trouble-free handling and use of the product.
- Observe the safety instructions and warnings in this documentation and on the product.
- Always keep the operating instructions with the product and make sure that the operating instructions are with the product when it is given to other persons.

### 1.2 Explanation of symbols used

#### 1.2.1 Warnings

Warnings alert persons to hazards that occur when handling or using the product. The following signal words are used:

#### **DANGER**

##### **DANGER !**

- ▶ Draws attention to imminent danger that will lead to serious personal injury or fatality.

#### **WARNING**

##### **WARNING !**

- ▶ Draws attention to a potential threat of danger that can lead to serious injury or fatality.





#### **CAUTION**

##### **CAUTION !**

- ▶ Draws attention to a potentially dangerous situation that could lead to slight personal injury or damage to the equipment or other property.

#### 1.2.2 Symbols in the documentation

The following symbols are used in this document:

|   |   |
|---|---|
|  | Read the operating instructions before use.                           |
|  | Instructions for use and other useful information                     |
|  | Dealing with recyclable materials                                     |
|  | Do not dispose of electric equipment and batteries as household waste |

#### 1.2.3 Symbols in the illustrations

The following symbols are used in illustrations:

|          |   |
|----------|---|
| <b>2</b> | These numbers refer to the corresponding illustrations found at the beginning of these operating instructions                             |
| 3        | The numbering reflects the sequence of operations shown in the illustrations and may deviate from the steps described in the text         |
| ⑪        | Item reference numbers are used in the <b>overview illustrations</b> and refer to the numbers used in the <b>product overview section</b> |
|          | This symbol is intended to draw special attention to certain points when handling the product.  |

### 1.3 Product-dependent symbols

#### 1.3.1 Symbols on the product

The following symbols are used:

|  |                     |
|--|---------------------|
|  | For indoor use only |
|  | Double insulated    |

### 1.4 Product information

**Hilti** products are designed for professional use and may be operated, serviced and maintained only by trained, authorized personnel. This personnel must be specifically informed about the possible hazards. The product and its ancillary equipment can present hazards if used incorrectly by untrained personnel or if used not in accordance with the intended use.

The type designation and serial number are printed on the rating plate.

- ▶ Write down the serial number in the table below. You will be required to state the product details when contacting Hilti Service or your local Hilti organization to inquire about the product.

#### Product information

|            |                                   |
|------------|-----------------------------------|
| Charger    | C4/36-90<br>C4/36-350<br>C4/36-DC |
| Generation | 01                                |
| Serial no. |                                   |

### 1.5 Declaration of conformity

We declare, on our sole responsibility, that the product described here complies with the applicable directives and standards. A copy of the declaration issued by the certification department can be found at the end of this documentation.

The technical documentation is filed here:

**Hilti** Entwicklungsgesellschaft mbH | Tool Certification | Hiltistrasse 6 | 86916 Kaufering, Germany

## 2 Safety

### 2.1 General power tool safety warnings

#### WARNING

**Read all safety warnings and all instructions.** Failure to follow the warnings and instructions may result in electric shock, fire and/or serious injury.

**Save all warnings and instructions for future reference.**

#### Work area safety

- ▶ **Keep work area clean and well lit.** Cluttered or dark areas invite accidents.
- ▶ **Do not operate power tools in explosive atmospheres, such as in the presence of flammable liquids, gases or dust.** Power tools create sparks which may ignite the dust or fumes.
- ▶ **Keep children and bystanders away while operating a power tool.** Distractions can cause you to lose control.

#### Electrical safety

- ▶ **Power tool plugs must match the outlet. Never modify the plug in any way. Do not use any adapter plugs with earthed (grounded) power tools.** Unmodified plugs and matching outlets will reduce risk of electric shock.
- ▶ **Avoid body contact with earthed or grounded surfaces, such as pipes, radiators, ranges and refrigerators.** There is an increased risk of electric shock if your body is earthed or grounded.
- ▶ **Do not expose power tools to rain or wet conditions.** Water entering a power tool will increase the risk of electric shock.
- ▶ **Do not abuse the cord. Never use the cord for carrying, pulling or unplugging the power tool. Keep cord away from heat, oil, sharp edges or moving parts.** Damaged or entangled cords increase the risk of electric shock.
- ▶ **When operating a power tool outdoors, use an extension cord suitable for outdoor use.** Use of a cord suitable for outdoor use reduces the risk of electric shock.
- ▶ **If operating a power tool in a damp location is unavoidable, use a residual current device (RCD) protected supply.** Use of an RCD reduces the risk of electric shock.

#### Personal safety

- ▶ **Stay alert, watch what you are doing and use common sense when operating a power tool. Do not use a power tool while you are tired or under the influence of drugs, alcohol or medication.** A moment of inattention while operating power tools may result in serious personal injury.
- ▶ **Use personal protective equipment. Always wear eye protection.** Protective equipment such as dust mask, non-skid safety shoes, hard

hat, or hearing protection used for appropriate conditions will reduce personal injuries.

- ▶ **Prevent unintentional starting. Ensure the switch is in the off-position before connecting to power source, picking up or carrying the tool.** Carrying power tools with your finger on the switch or energising power tools that have the switch on invites accidents.
- ▶ **Remove any adjusting key or wrench before turning the power tool on.** A wrench or a key left attached to a rotating part of the power tool may result in personal injury.
- ▶ **Do not overreach. Keep proper footing and balance at all times.** This enables better control of the power tool in unexpected situations.
- ▶ **Dress properly. Do not wear loose clothing or jewellery. Keep your hair, clothing and gloves away from moving parts.** Loose clothes, jewellery or long hair can be caught in moving parts.
- ▶ **If devices are provided for the connection of dust extraction and collection facilities, ensure these are connected and properly used.** Use of dust collection can reduce dust-related hazards.

#### **Power tool use and care**

- ▶ **Do not force the power tool. Use the correct power tool for your application.** The correct power tool will do the job better and safer at the rate for which it was designed.
- ▶ **Do not use the power tool if the switch does not turn it on and off.** Any power tool that cannot be controlled with the switch is dangerous and must be repaired.
- ▶ **Disconnect the plug from the power source from the power tool before making any adjustments, changing accessories, or storing power tools.** Such preventive safety measures reduce the risk of starting the power tool accidentally.
- ▶ **Store idle power tools out of the reach of children and do not allow persons unfamiliar with the power tool or these instructions to operate the power tool.** Power tools are dangerous in the hands of untrained users.
- ▶ **Maintain power tools. Check for misalignment or binding of moving parts, breakage of parts and any other condition that may affect the power tool's operation. If damaged, have the power tool repaired before use.** Many accidents are caused by poorly maintained power tools.
- ▶ **Keep cutting tools sharp and clean.** Properly maintained cutting tools with sharp cutting edges are less likely to bind and are easier to control.
- ▶ **Use the power tool, accessories and tool bits etc. in accordance with these instructions, taking into account the working conditions and the work to be performed.** Use of the power tool for operations different from those intended could result in a hazardous situation.



## 2.2 Battery charger use and care

- ▶ To avoid injury, use the charger only to charge **Hilti** Li-ion batteries approved for use with this charger.
- ▶ The location at which the charger is used should be clean and cool but protected from frost.
- ▶ The charger must be able to emit heat while in operation. The air vents must therefore remain unobstructed. Accordingly, remove the charger from the toolbox. Do not operate the charger inside a closed container.
- ▶ Maintain the appliance carefully. Check to ensure that no parts are broken or damaged in such a way that the appliance may no longer function correctly. If parts are damaged, have the parts repaired before using the appliance.
- ▶ Use chargers and the corresponding batteries in accordance with these instructions and as is specified for this particular model. Use of chargers for applications different from those intended could result in hazardous situations.
- ▶ Recharge the batteries only with the chargers specified by the manufacturer. A charger that is suitable for a certain type of battery may present a risk of fire when used with other types of battery.
- ▶ When not in use, keep the battery and the charger away from paper clips, coins, keys, nails, screws or other small metal objects that could cause a short circuit at the battery terminals or the charging contacts. A short circuit between the battery terminals or charging contacts may cause injuries (burns) and result in fire.
- ▶ Under abusive conditions, liquid may be ejected from the battery. Avoid contact with the liquid. If contact accidentally occurs, flush with water. If the liquid contacts the eyes, also seek medical attention. Liquid leaking from the battery may cause irritation or burns.
- ▶ **Make sure that the batteries suffer no mechanical damage.**
- ▶ Do not charge or continue to use damaged batteries (e.g. batteries with cracks, broken parts, bent or pushed-in and/or pulled-out contacts).

## 2.3 Battery use and care

- ▶ Observe the special regulations and instructions applicable to the transport, storage and use of Li-ion batteries.
- ▶ Do not expose batteries to high temperatures, direct sunlight or fire.
- ▶ Do not disassemble, crush or incinerate batteries and do not subject them to temperatures over 80 °C.
- ▶ Do not use or charge batteries that have suffered mechanical impact, have been dropped from a height or show signs of damage. In this case, always contact your **Hilti Service**.
- ▶ If the battery is too hot to touch it may be defective. In this case, place the product in a non-flammable location, well away from flammable materials,

where it can be kept under observation and allowed to cool down. In this case, always contact your **Hilti Service**.

### 3 Description

#### 3.1 Product overview

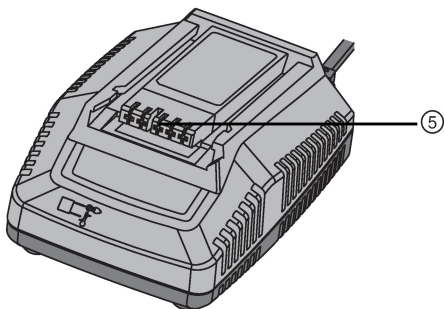
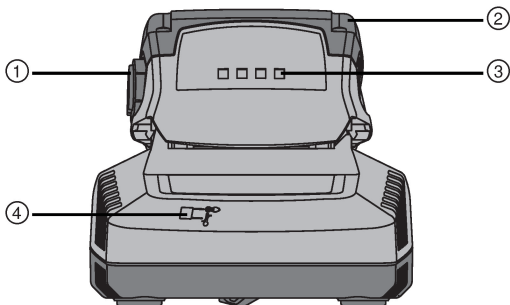

- |  |  |
|--|--|
| ① Release button with additional function (state of charge display activation) | ③ Battery state of charge LED indicators |
| ② Battery  | ④ Indicator LED                          |
|  | ⑤ Battery interface                      |

### 3.2 Intended use

The product described is a battery charger for **Hilti** Li-Ion batteries with a rated voltage of 7.2 to 36 volts. It is designed to be connected to power outlets providing an AC (alternating current) voltage of 100 to 127 volts or 220 to 240 volts (depending on country-specific version).

The C4-36-DC charger can be connected to a 12 volt or 24 volt DC electric supply socket in a motor vehicle.

The batteries approved for use with this product are listed at the end of this document.

Not all batteries are available in all markets.

### 3.3 Information displayed

#### 3.3.1 Information displayed by the charger and battery

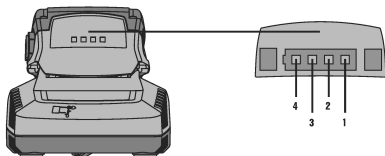

| Display                | On the battery   | On the charger                                    |
|------------------------|--|---|
| LED lights constantly. | Indication of state of charge.   | The charger is connected and ready for operation. |
| Blinking.              | Charging is in progress.   | The battery is too hot or too cold.               |
| LED doesn't light.     | Green LED on the charger lights constantly, no LEDs light on the battery: Battery malfunction. | Charger malfunction.                              |

### 3.3.2 Li-ion battery state of charge display

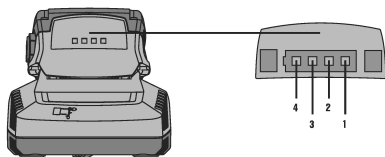

| Status                      | Meaning                        |
|-----------------------------|--------------------------------|
| 4 LEDs light.               | State of charge: 100 %         |
| 3 LEDs light, 1 LED blinks. | State of charge: 75 % to 100 % |
| 2 LEDs light, 1 LED blinks. | State of charge: 50 % to 75 %  |
| 1 LED lights, 1 LED blinks. | State of charge: 25 % to 50 %  |
| 1 LED blinks.               | State of charge: < 25 %        |

### 3.4 Items supplied

Charger, operating instructions.

Other system products approved for use with this product can be found at your local **Hilti Store** or at: [www.hilti.group](http://www.hilti.group) | USA: [www.hilti.com](http://www.hilti.com)

## 4 Technical data

|                       |             | C 4/36-90          | C 4/36-350         | C 4/36-DC          |
|-----------------------|-------------|--------------------|--------------------|--------------------|
| <b>Weight</b>         |             | 1.3 lb<br>(0.6 kg) | 2.4 lb<br>(1.1 kg) | 1.3 lb<br>(0.6 kg) |
| <b>Output voltage</b> |             | 7.2 V ... 36 V     | 7.2 V ... 36 V     | 7.2 V ... 36 V     |
| <b>Output power</b>   | <b>12 V</b> | •/•                | •/•                | 60 W               |
|                       | <b>24 V</b> | •/•                | •/•                | 60 W               |

## 5 Operation

### 5.1 Switching on the C 4/36-90 and C 4/36-350 charger

C 4/36-90

C 4/36-350

- ▶ Plug the supply cord into the power outlet.
  - ↳ The green LED on the charger lights.

### 5.2 Switching the C 4/36-DC charger on

C 4/36-DC

**i** When charging a **Hilti** battery with the C 4/36-DC charger, the motor vehicle's starter battery may discharge to such an extent that the battery is no longer capable of fulfilling its purpose

Depending on how the motor vehicle's electrical system is configured, the charger will either receive power immediately or only after the ignition is switched on.

- ▶ Plug the supply cord into the motor vehicle's cigarette lighter socket.
  - ↳ The green LED on the charger lights constantly when the input voltage is correct.

### 5.3 Inserting and charging the battery

**i** The battery will suffer no damage even when left in the charger for long periods. In this case it is necessary that the charger is operating (green LED on the charger must be lit). The battery state of charge LED goes out after some time, even though the battery is fully charged, and cannot be subsequently reactivated to indicate the state of charge. For safety reasons, it is recommended that the battery is removed from the charger after completion of the charging cycle.

Li-ion batteries are ready for use at any time, even when only partly charged. Charging progress is indicated by the LEDs.

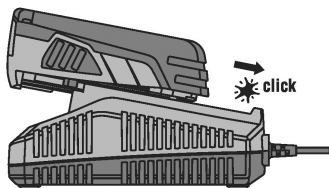

1. Before inserting the battery, check that the contacts are clean and free from grease.
2. Push the battery into the interface provided.
3. Check that the battery and charger interfaces match (keyed fit).
  - ↳ Charging begins automatically after insertion of the battery in the charger.

#### 5.4 Removing the battery

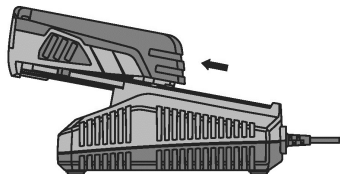

1. Press the catch to release the battery.
2. Pull the battery out of the charger.

## 6 Troubleshooting

| Malfunction   | Possible cause  | Action to be taken   |
|---|---|--|
| LEDs on the battery don't light, battery is in the charger. | The battery may be defective.                                   | ▶ Remove the battery from the charger. If no LED lights on the battery after activation of the state of charge indicator, the battery is defective. Have the battery checked by <b>Hilti Service</b> . |
| LEDs on the charger blink.                                  | The battery is too hot or too cold: the battery doesn't charge. | ▶ The charger switches automatically to charging mode as soon as the battery reaches the required temperature.   |
| LEDs on the charger don't light.                            | Charger malfunction.  | ▶ Unplug the appliance and then plug it back in. If the LED still doesn't light, please bring the charger to <b>Hilti Service</b> .  |

## 7 Care and maintenance

### WARNING

**Electric shock hazard!** Attempting care and maintenance with the supply cord connected to a power outlet can lead to severe injury and burns.

- ▶ Always unplug the supply cord before carrying out care and maintenance tasks.

### Care

- Carefully remove any dirt that may be adhering to parts.
- Clean the air vents carefully with a dry brush.
- Use only a slightly damp cloth to clean the casing. Do not use cleaning agents containing silicone as these may attack the plastic parts.

### Maintenance

### WARNING

**Danger of electric shock!** Improper repairs to electrical components may lead to serious injuries including burns.

- ▶ Repairs to the electrical section of the tool or appliance may be carried out only by trained electrical specialists.

- Check all visible parts and controls for signs of damage at regular intervals and make sure that they all function correctly.
- Do not operate the product if signs of damage are found or if parts malfunction. Have it repaired immediately by **Hilti** Service.
- After cleaning and maintenance, fit all guards or protective devices and check that they function correctly.



To help ensure safe and reliable operation, use only genuine Hilti spare parts and consumables. Spare parts, consumables and accessories approved by Hilti for use with the product can be found at your local **Hilti Store** or online at: [www.hilti.group](http://www.hilti.group).

## 8 Disposal

### **WARNING**

**Risk of injury.** Hazards presented by improper disposal.

- ▶ Improper disposal of the equipment may have the following consequences: The burning of plastic components generates toxic fumes which may present a health hazard. Batteries may explode if damaged or exposed to very high temperatures, causing poisoning, burns, acid burns or environmental pollution. Careless disposal may permit unauthorized and improper use of the equipment. This may result in serious personal injury, injury to third parties and pollution of the environment.
- ▶ Dispose of defective batteries right away. Keep them out of reach of children. Do not disassemble or incinerate the batteries.
- ▶ Batteries that have reached the end of their life must be disposed of in accordance with national regulations or returned to **Hilti**.

Most of the materials from which **Hilti** tools and appliances are manufactured can be recycled. The materials must be correctly separated before they can be recycled. In many countries, your old tools, machines or appliances can be returned to **Hilti** for recycling. Ask **Hilti** Service or your Hilti representative for further information.

## 9 Manufacturer's warranty

- ▶ Please contact your local **Hilti** representative if you have questions about the warranty conditions.



This Product is Certified  
Ce produit est homologué  
Producto homologado por  
Este produto está registrado



## DC Charger

### Safety note:

For replacing the fuse inside the cigarette lighter plug use only the same type of fuse (5 x 20 mm / 250 V / 8 A).

en

### Indications de sécurité :

En cas de remplacement du fusible dans la fiche allume-cigare, utiliser exclusivement le type respectif (5 x 20 mm / 250 V / 8 A).

fr

### Advertencia de seguridad:

Para sustituir el fusible del conector del encendedor de cigarrillos, utilice exclusivamente el modelo instalado (5 x 20 mm / 250 V / 8 A).

es

### Indicação de segurança:

Ao substituir o fusível na tomada de isqueiro deverá utilizar exclusivamente o modelo instalado (5 x 20 mm / 250 V / 8 A).

pt

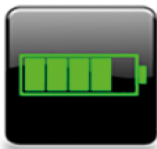

|         |      |         |      |
|---------|------|---------|------|
| B12/2.6 | (01) | B22/1.6 | (01) |
| B12/4.0 | (01) | B22/2.6 | (02) |
| CA-B12  |      | B22/3.0 | (01) |
|         |      | B22/3.3 | (01) |
| B14/1.6 | (01) | B22/4.0 | (01) |
| B14/2.6 | (01) | B22/5.2 | (01) |
| B14/3.3 | (01) | B22.8.0 | (01) |
| B14/5.2 | (01) |         |      |
|         |      | B36/3.0 | (01) |
| B18/2.6 | (01) | B36/3.9 | (01) |
| B18/1.6 | (01) | B36/2.6 | (01) |
| B18/3.3 | (01) | B36/5.2 | (01) |
| B18/2.6 | (02) | B36/6.0 | (01) |
| B18/5.2 | (01) | B36/9.0 | (01) |





Hilti Corporation  
LI-9494 Schaan  
Tel.: +423 234 21 11  
Fax: +423 234 29 65  
[www.hilti.group](http://www.hilti.group)



2164701



Hilti Connect