

HILTI

TE SX

Bedienungsanleitung

de

Operating instructions

en

Mode d'emploi

fr

Istruzioni d'uso

it



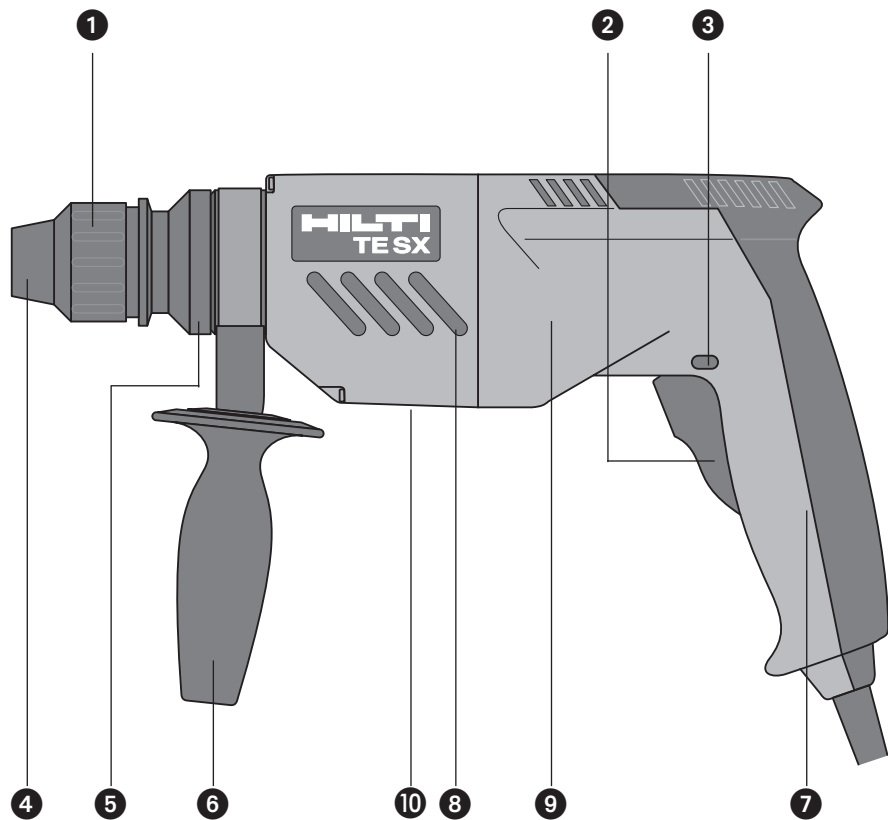

ORIGINAL OPERATING INSTRUCTIONS

TE SX Rotary Hammer Drill

It is essential that the operating instructions are read before the tool is operated for the first time.

Always keep these operating instructions together with the tool.

Ensure that the operating instructions are with the tool when it is given to other persons.

Operating controls **1**

- 1** Chuck locking sleeve
- 2** Electronic switch
- 3** Selector switch for automatic function

Tool components **1**

- 4** Dust shield
- 5** Chuck
- 6** Side handle
- 7** Grip
- 8** Hammering mechanism / gearing
- 9** Motor
- 10** Type plate

Contents	Page
General information	9
Description	9
Technical data	10
Safety rules	11
Preparation for use	13
Operation	13
Care and maintenance	14
Manufacturer's warranty – tools	15
Disposal	15
Trouble shooting	15
EC declaration of conformity (original)	16

General information

 In these operating instructions, this symbol indicates points of particular importance to safety. The instructions at these points must always be observed in order to avoid the risk of serious injury.

 Caution: high voltage

Obligation signs



Wear ear protection.



Wear protective gloves.



Wear eye protection.



Wear breathing protection.

Symbols



Read the operating instructions before use.



Return waste material for recycling.



Revolutions per minute



Watt



Amps



Hertz



Volts

1 The numbers refer to the illustrations. The illustrations can be found on the fold-out cover pages. Keep these pages open while you read the operating instructions.

In these operating instructions, the power tool to which these operating instructions apply is referred to as “the tool”.

Description

The TE SX is an electrically powered rotary hammer drill with pneumatic hammering mechanism. It is designed for professional use in SX insulation fastener applications.

The following items are supplied: electric tool, side handle, operating instructions, grease, cleaning cloth, tool box, ear protectors.

 **The following conditions must always be observed when the tool is in use:**

- The tool must be connected to an alternating current electric supply in compliance with the information given on the type plate.
- The tool is for hand-held use only.
- The tool must not be used in places where the surrounding conditions may present a risk of explosion.

Technical data

Rated power	500 W
Nominal voltage *	100 V, 110 V, 120 V, 220 V, 230 V, 240 V
Nominal current input *	5.3 A, 4.8 A, 4.6 A, 2.4 A, 2.3 A, 2.2 A
Frequency	50–60 Hz
Weight as per EPTA-Procedure 01/2003	2.8 kg
Dimensions (l×h×w)	340×210×76 mm
Minimum distance between wall and hole drilled	38 mm
Speed	Automatic function ON 700 /min Automatic function OFF 900 /min
Single impact energy	Automatic function ON 0.7 j Automatic function OFF 1.0 j
Hammering speed under load	4680/min.

* **The tool is offered in different versions for various nominal voltages. Please refer to the information on the type plate for the nominal voltage and nominal current input of your tool.**

-NOTE-

The vibration emission level given in this information sheet has been measured in accordance with a standardised test given in EN 60745 and may be used to compare one tool with another. It may be used for a preliminary assessment of exposure. The declared vibration emission level represents the main applications of the tool. However if the tool is used for different applications, with different accessories or poorly maintained, the vibration emission may differ. This may significantly increase the exposure level over the total working period. An estimation of the level of exposure to vibration should also take into account the times when the tool is switched off or when it is running but not actually doing the job. This may significantly reduce the exposure level over the total working period. Identify additional safety measures to protect the operator from the effects of vibration such as: maintain the tool and the accessories, keep the hands warm, organisation of work patterns.

Noise and vibration information (according to EN 60745)

Typical A-weighted sound power level	88 dB(A)
Typical A-weighted emission sound pressure level	99 dB(A)

For the given sound power level as per EN 60745, the tolerance is 3 dB.

Wear ear protection!

Triaxial vibration value (vibration vector sum) measured in accordance with EN 60745-2-6 prAB: 2005	
Hammer drilling in concrete, ($a_{h, HD}$)	14.0 m/s ²
Uncertainty (K) for triaxial vibration value	1.5 m/s ²

Main features of the tool

Electrical protection class II (double insulated) 
Radio and TV interference suppression as per EN 55014-1
Immunity to interference as per EN 55014-2
Slip clutch overload protection
No-load hammering absorption
Vibration-absorbing side handle
Quick-change chuck
TE SX connection end
Automatic function selector switch – full power (OFF) and reduced power (ON)
Drilling mode
Gearing and hammering mechanism with permanent lubrication
Automatic cut-out carbon brushes
Adjustable side handle

Right of technical changes reserved

The tool is designed for the following uses

Operating mode	Insert tool required	Drilling dia. range
Setting SX insulation fasteners in masonry	Drill bit with TE SX connection end	8 mm
Drilling in masonry and natural stone	Drill bit with TE-C or SDS connection end	4–16 mm

Use the tool only for the purposes for which it is intended.

Safety instructions

NOTE

The safety rules in section 1 contain all general safety rules for power tools which, in accordance with the applicable standards, require to be listed in the operating instructions. Accordingly, some of the rules listed may not be relevant to this tool.

1. General Power Tool Safety Warnings

- a)  **WARNING! Read all safety warnings and all instructions.** Failure to follow the warnings and instructions may result in electric shock, fire and/or serious injury. **Save all warnings and instructions for future reference.** The term "power tool" in the warnings refers to your mains-operated (corded) power tool or battery-operated (cordless) power tool.

1.1 Work area safety

- a) **Keep work area clean and well lit.** Cluttered or dark areas invite accidents.
- b) **Do not operate power tools in explosive atmospheres, such as in the presence of flammable liquids, gases or dust.** Power tools create sparks which may ignite the dust or fumes.
- c) **Keep children and bystanders away while operating a power tool.** Distractions can cause you to lose control.

1.2 Electrical safety

- a) **Power tool plugs must match the outlet. Never modify the plug in any way. Do not use any adapter plugs with earthed (grounded) power tools.** Unmodified plugs and matching outlets will reduce risk of electric shock.
- b) **Avoid body contact with earthed or grounded surfaces, such as pipes, radiators, ranges and refrigerators.** There is an increased risk of electric shock if your body is earthed or grounded.
- c) **Do not expose power tools to rain or wet conditions.** Water entering a power tool will increase the risk of electric shock.
- d) **Do not abuse the cord. Never use the cord for carrying, pulling or unplugging the power tool. Keep cord away from heat, oil, sharp edges or moving parts.** Damaged or entangled cords increase the risk of electric shock.
- e) **When operating a power tool outdoors, use an extension cord suitable for outdoor use.** Use of a cord suitable for outdoor use reduces the risk of electric shock.

- f) **If operating a power tool in a damp location is unavoidable, use a residual current device (RCD) protected supply.** Use of an RCD reduces the risk of electric shock.

1.3 Personal safety

- a) **Stay alert, watch what you are doing and use common sense when operating a power tool. Do not use a power tool while you are tired or under the influence of drugs, alcohol or medication.** A moment of inattention while operating power tools may result in serious personal injury.
- b) **Use personal protective equipment. Always wear eye protection.** Protective equipment such as dust mask, non-skid safety shoes, hard hat, or hearing protection used for appropriate conditions will reduce personal injuries.
- c) **Prevent unintentional starting. Ensure the switch is in the off-position before connecting to power source and/or battery pack, picking up or carrying the tool.** Carrying power tools with your finger on the switch or energising power tools that have the switch on invites accidents.
- d) **Remove any adjusting key or wrench before turning the power tool on.** A wrench or a key left attached to a rotating part of the power tool may result in personal injury.
- e) **Do not overreach. Keep proper footing and balance at all times.** This enables better control of the power tool in unexpected situations.
- f) **Dress properly. Do not wear loose clothing or jewellery. Keep your hair, clothing and gloves away from moving parts.** Loose clothes, jewellery or long hair can be caught in moving parts.
- g) **If devices are provided for the connection of dust extraction and collection facilities, ensure these are connected and properly used.** Use of dust collection can reduce dust-related hazards.

1.4 Power tool use and care

- a) **Do not force the power tool. Use the correct power tool for your application.** The correct power tool will do the job better and safer at the rate for which it was designed.
- b) **Do not use the power tool if the switch does not turn it on and off.** Any power tool that cannot be controlled with the switch is dangerous and must be repaired.

- c) **Disconnect the plug from the power source and/or the battery pack from the power tool before making any adjustments, changing accessories, or storing power tools.** Such preventive safety measures reduce the risk of starting the power tool accidentally.
- d) **Store idle power tools out of the reach of children and do not allow persons unfamiliar with the power tool or these instructions to operate the power tool.** Power tools are dangerous in the hands of untrained users.
- e) **Maintain power tools.** Check for misalignment or binding of moving parts, breakage of parts and any other condition that may affect the power tool's operation. If damaged, have the power tool repaired before use. Many accidents are caused by poorly maintained power tools.
- f) **Keep cutting tools sharp and clean.** Properly maintained cutting tools with sharp cutting edges are less likely to bind and are easier to control.
- g) **Use the power tool, accessories and tool bits etc. in accordance with these instructions, taking into account the working conditions and the work to be performed.** Use of the power tool for operations different from those intended could result in a hazardous situation.

1.5 Service

- a) **Have your power tool serviced by a qualified repair person using only identical replacement parts.** This will ensure that the safety of the power tool is maintained.

2. Additional safety precautions

2.1 Personal safety

- a) **Wear ear protectors.** Exposure to noise can cause hearing loss.
- b) **Use auxiliary handle(s), if supplied with the tool.** Loss of control can cause personal injury.
- c) **Hold power tool by insulated gripping surfaces, when performing an operation where the cutting accessory may contact hidden wiring or its own cord.** Cutting accessory contacting a "live" wire may make exposed metal parts of the power tool "live" and could give the operator an electric shock.
- d) **Breathing protection must be worn when the tool is used without a dust removal system for work that creates dust.**
- e) **To avoid tripping and falling when working, always lead the supply cord, extension cord and dust extraction hose away to the rear.**
- f) **The tool is not intended for use by children, by debilitated persons or those who have received no instruction or training.**
- g) **Children must be instructed not to play with the tool.**
- h) **Dust from material such as paint containing lead, some wood species, minerals and metal may be harmful. Contact with or inhalation of the dust may cause allergic reactions and/or respiratory diseases to the operator or bystanders. Certain kinds of dust are classified as carcinogenic such as oak and beech dust especially in conjunction with additives for wood conditioning (chromate, wood preservative). Material containing asbestos must only be treated by specialists.**

Where the use of a dust extraction device is possible it shall be used. To achieve a high level of dust collection, use a suitable vacuum cleaner of the type recommended by Hilti for wood dust and/or mineral dust together with this tool. Ensure that the workplace is well ventilated. The use of a dust mask of filter class P2 is recommended. Follow national requirements for the materials you want to work with.

2.2 Power tool use and care

- a) **Secure the workpiece. Use clamps or a vice to hold the workpiece in place.** *The workpiece is thus held more securely than by hand and both hands remain free to operate the tool.*
- b) **Ensure that the insert tools used are equipped with the appropriate connection end system and that they are properly fitted and secured in the chuck.**
- c) **In the event of a power failure, switch the tool off and unplug the supply cord.** *This prevents inadvertent starting when the power returns.*

2.3 Electrical safety

- a) **Before beginning work, check the working area (e.g. with a metal detector) to ensure that no concealed electric cables or gas and water pipes are present.** *External metal parts of the tool may become live if, for example, an electric cable is damaged inadvertently. This presents a serious risk of electric shock.*
- b) **Check the condition of the supply cord and its plug connections and have it replaced by a qualified electrician if damage is found. Check the condition of the extension cord and replace it if damage is found. Do not touch the supply in the event of it suffering damage while working. Disconnect the supply cord plug from the socket.** *Damaged supply cords and extension cords present a risk of electric shock.*
- c) **Dirty or dusty electric tools should thus be checked at a Hilti service center at regular intervals, especially if used frequently for working on conductive materials.** Dust (especially dust from conductive materials) or dampness adhering to the surface of the tool may, under unfavorable conditions, present a risk of electric shock.

2.4 Work area

- a) **Ensure that the workplace is well lit.**
- b) **Ensure that the workplace is well ventilated.** *Poorly ventilated workplaces may be injurious to the health due to exposure to dust.*

2.5 Personal protective equipment

The user and any other persons in the vicinity must wear suitable eye protection, ear protection and protective gloves when the tool is in use. Breathing protection must be worn if no dust removal system is used.



Wear eye protection



Wear ear protection



Wear protective gloves



Wear breathing protection

Preparation for use



It is essential that the safety precautions printed in these operating instructions are read and observed.



The supply voltage must correspond to the information on the type plate.



If extension cords are used: Only extension cords of a type approved for the intended use and of adequate cross section may be used. Failure to observe this point may result in reduced performance of the tool and overheating of the cord. Damaged extension cords must be replaced. The recommended cross-sections and max. length for extension cords are:

Recommended minimum conductor cross-section

Mains voltage	Conductor cross-section			
	1.5 mm ²	2.5 mm ²	16 AWG	14 AWG
100 V	20 m	40 m		
110–120 V			30 ft	100 ft
220–230 V	50 m	100 m		

Use only insert tools with TE SX or TE-C resp. SDS connection ends (fig. 8).

Don't exert excessive pressure on the tool. This will not increase its hammering power.

At low temperatures: The tool requires a minimum operating temperature before the hammering mechanism begins to operate. Switch on the tool and position the tip of the drill bit on the work surface. While the tool is running, apply light pressure briefly and repeatedly until the hammering mechanism begins to operate.

Operation



CAUTION:

In the event of the drill bit sticking, the tool will pivot about its own axis.

Always use the tool with the side handle fitted and hold it securely with both hands applying an opposing torque so that the clutch releases in the event of the drill bit sticking.

Use a vice or clamp to secure loose workpieces.

Choosing the drill bit

Use only drill bits with TE SX or TE-C resp. SDS connection ends (fig. 8).

Hilti power tools have been designed to work optimally as a system together with Hilti drill bits. Accordingly, highest performance and longest life expectancy can be achieved when using this power tool with Hilti drill bits.

To ensure optimum fastening quality, only SX-D drill bits may be used when installing SX insulation fasteners.



Check your drill bits at regular intervals and replace them in good time. A damaged or badly worn connection end may result in damage to the power tool. Drill bits with chipped or broken carbide tips may no longer drill holes of the specified diameter, thus influencing their suitability for insulation fastenings.

Inserting the drill bit

- Unplug the supply cord from the electrical socket to prevent unintentional starting.
- Check that the connection end of the drill bit is clean and lightly greased. Clean it and grease it if necessary 2. Check that the sealing lip of the dust shield is clean. Wipe it off if necessary. Take care to ensure that no drilling dust finds its way into the interior of the chuck. The dust shield must be replaced when the sealing lip is damaged. Please refer to the section on care and maintenance.
- Turn the chuck locking sleeve (fig. 6) towards the III (⦿) symbol. Push the drill bit into the chuck as far as possible II and then rotate the insert tool until the driving grooves engage and the tool can be pushed all the way into the chuck. Turn the chuck locking sleeve towards the I (●) symbol to lock the drill bit in the chuck.



Drilling



- Drilling may cause splintering of the material. Splinters may cause injury to parts of the body and eyes. Wear eye protection, protective gloves and breathing protection if no dust removal system is used.
- The tool and the drilling operation emit noise. Excessive noise may damage the hearing. Wear ear protection.
- Switch the tool on only once it has been brought into the working position close to the workpiece.
- Avoid contact with rotating parts.
- Exercise your fingers during pauses between work to improve the blood circulation in your fingers.

- Insert the supply cord plug in the mains socket.
- Select desired drilling power by means of selector switch for automatic function ON/OFF (fig. 7).
ON-function: Tool starts with reduced r.p.m. and hammering power. Used on hollow bricks with low density and no plaster coating. Maximum holding values of SX insulation fasteners will be achieved.
OFF-function: Full r.p.m. and hammering power. Used on solid materials and masonry with plaster coating to ensure a quick and secure setting of SX insulation fasteners.
- Position tool and drill bit at desired drill point and press the electronic switch.

Removing the drill bit

- a)  Unplug the supply cord from the electrical socket to prevent unintentional starting.
- b) Turn the chuck locking sleeve towards the III () symbol and pull the drill bit out of the chuck.
  Wear protective gloves. The drill bit may be very hot after long periods of use.

Changing the chuck

Pull the ring on the TESX chuck towards the front end and remove the chuck completely (fig. 4). To replace the chuck, pull the ring towards the front end and hold it in this position. Push the chuck onto the guide tube as far as possible and release the ring. Rotate the chuck until the ring snaps into position towards the rear (fig. 5).

Care and maintenance

Unplug the supply cord from the mains socket.

Care of the tool

-CAUTION-

Keep the power tool, especially its grip surfaces, clean and free from oil and grease. Do not use cleaning agents which contain silicone.

The outer casing of the tool is made from impactresistant plastic. Sections of the grip are made from a synthetic rubber material. Never operate the tool when the ventilation slots are blocked. Clean the ventilation slots carefully using a dry brush. Do not permit foreign objects to enter the interior of the tool. Clean the outside of the tool at regular intervals with a slightly damp cloth. Do not use a spray, steam pressure cleaning equipment or running water for cleaning. This may negatively affect the electrical safety of the tool.

Clean the dust shield on the chuck at regular intervals using a clean, dry cloth. Carefully wipe the sealing lip and grease it with a little Hilti grease. **It is essential to replace the dust shield when the sealing lip is damaged.** Proceed as follows: Insert a screwdriver at the edge of the dust shield and lift it out in a forwards direction. Clean the contact surface and insert a new dust shield. Press it in firmly until it engages.

Also take care of your drill bits. Clean off dirt and dust deposits and protect your drill bits from corrosion by wiping them from time to time with an oil-soaked rag. Always keep the connection end clean and lightly greased.

Maintenance

 Regularly check all external parts of the tool for damage and that all controls operate faultlessly. Don't operate the tool when parts are damaged or when the controls do not function faultlessly. Have your tool repaired by a Hilti service center.

Manufacturer's warranty – tools

Please contact your local Hilti representative if you have questions about the warranty conditions.

Disposal



Most of the materials from which Hilti power tools are manufactured can be recycled. The materials must be correctly separated before they can be recycled. In many countries, Hilti has already made arrangements for taking back your old electric tools for recycling. Please ask your Hilti customer service department or Hilti sales representative for further information.



Only for EU countries

Disposal of electric tools together with household waste is not permissible!

In observance of European Directive on waste electrical and electronic equipment and its implementation in accordance with national law, electric tools that have reached the end of their life must be collected separately and returned to an environmentally compatible recycling facility.

Trouble shooting

Symptom	Possible cause	Possible solution
The tool doesn't start	Fault in the electric power supply	Plug in another electric tool and check whether it starts
	Defective supply cord or plug	Have it checked by an electrical specialist and replace if necessary
	Switch defective	Have it checked by an electrical specialist and replace if necessary
No hammering action	The tool is too cold	Allow tool to reach the minimum operating temperature (see section "Preparation for use")
The tool does not produce full power (Switch for automatic function in OFF position)	Cross-section of the extension cable is inadequate	Use an extension cable of adequate cross-section (see section "Before use")
The tool does not switch to faster speed after the given time (approx. 5 sec.) (Switch for automatic function in ON position)	Switch for automatic function is defective	Move switch for automatic function to OFF position and have the electronic switch immediately replaced
The drill bit cannot be released from the chuck	The chuck locking sleeve is not turned fully towards the () symbol (fig. 6)	Turn the chuck locking sleeve fully towards the () symbol (fig. 6)

EC declaration of conformity (original)

Description:	Rotary hammer
Designation:	TE SX
Year of desing:	2000

We declare, under our sole responsibility, that this product complies with the following directives and standards: until 19th April 2016: 2004/108/EC, from 20th April 2016: 2014/30/EU, 2006/42/EC, 2011/65/EU, EN 60745-1, EN 60745-2-1, EN 60745-2-6, EN ISO 12100.

**Hilti Aktiengesellschaft, Feldkircherstrasse 100,
FL-9494 Schaan**



Paolo Luccini
Head of BA
Quality and Process Management
Business Area
Electric Tools & Accessories
05/2015

Tassilo Deinzer
Executive Vice President
Business Unit
Power Tools & Accessories

05/2015

Technical documentation filed at:
Hilti Entwicklungsgesellschaft mbH
Zulassung Elektrowerkzeuge
Hiltistrasse 6
86916 Kaufering
Deutschland



Hilti Corporation

LI-9494 Schaan

Tel.: +423 / 234 21 11

Fax: +423 / 234 29 65

www.hilti.com

Hilti = registered trademark of Hilti Corp., Schaan
Pos. 1 | 20150922



334041