

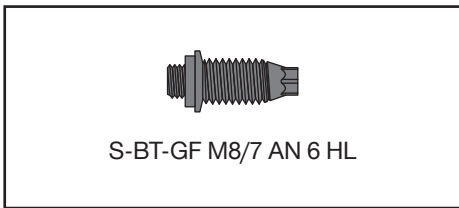

S-BT-GF M8/7 AN 6 HL

2353581-03.2023

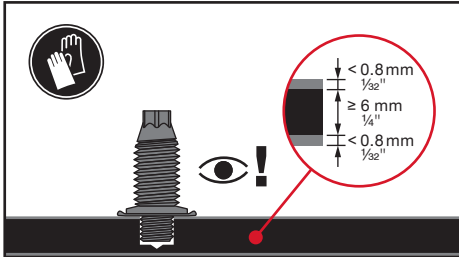

	SBT 4	SBT 6 SF 6
	TS-BT 5.3-95 S	
	S-DG BT M8/7 Short 6	
	Torque Tool S-BT 1/4" 16 Nm / 11.8 lb-ft	
	S-NS 13 C 95/3 3/4"	
	S-CC BT 6	

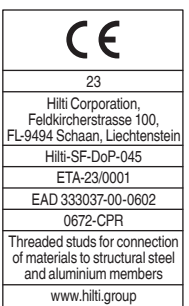
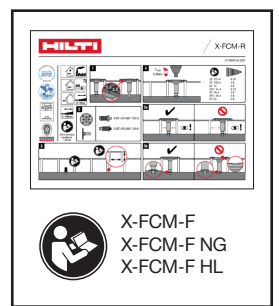
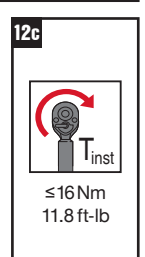
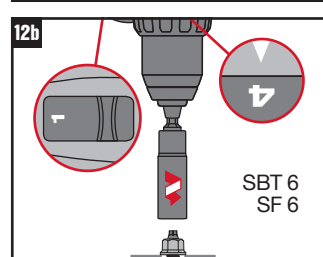
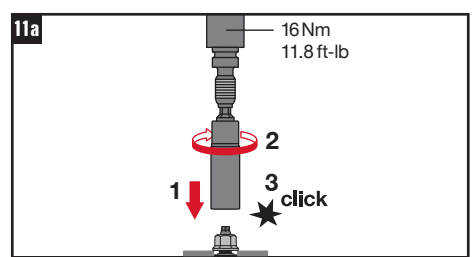
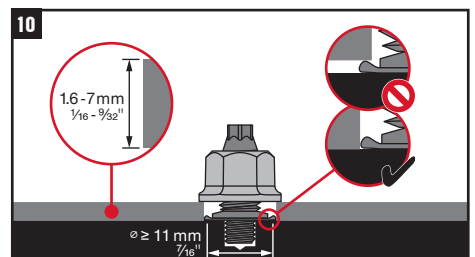
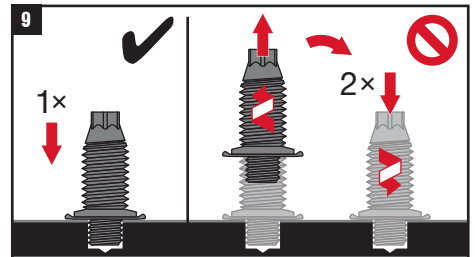
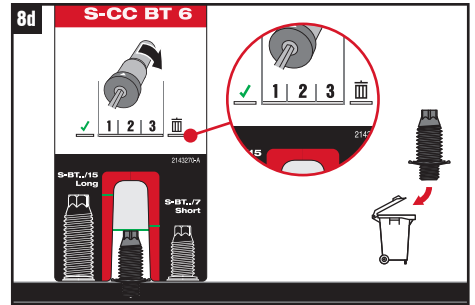
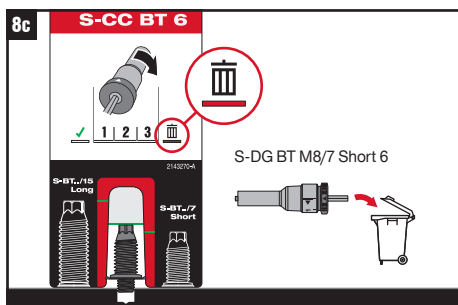
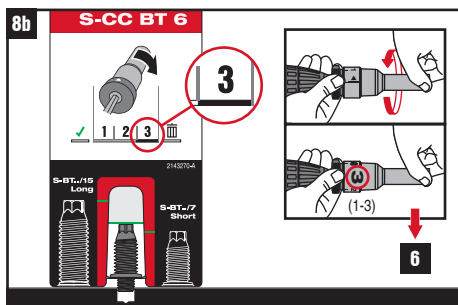
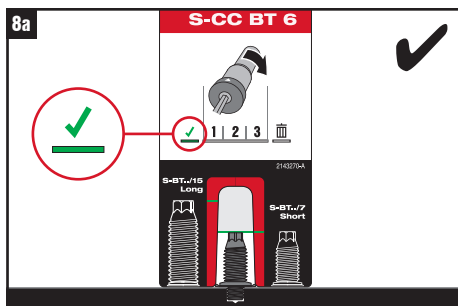
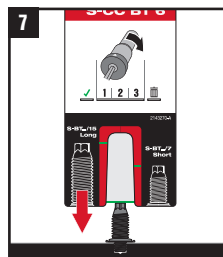
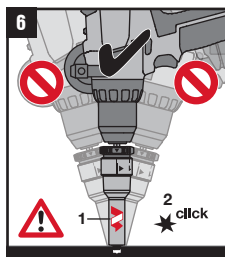
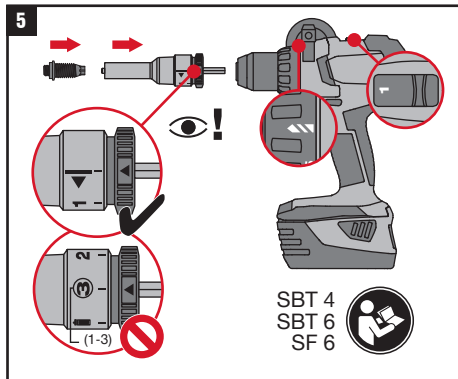
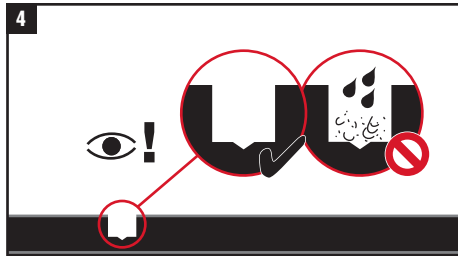
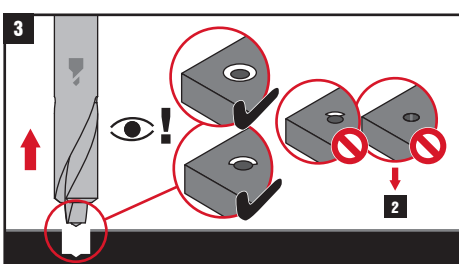
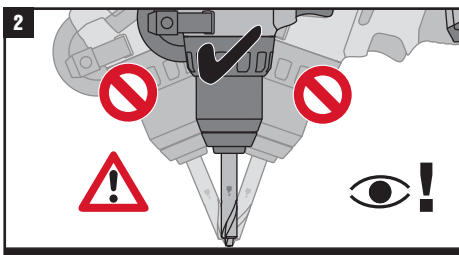
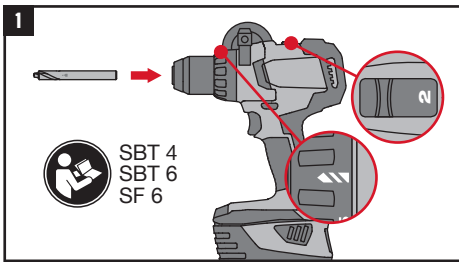

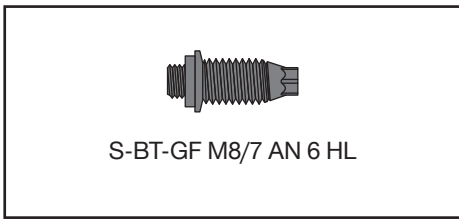
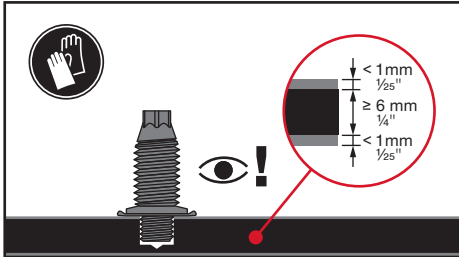

	SBT 6
	TS-BT 5.3-95 S
	S-SH BT M8
	Torque Tool S-BT 1/4" 16 Nm / 11.8 lb-ft
	S-NS 13 C 95/3 1/4"
	S-IC BT

